



Z-N326

Z-N426



INFOTAINER
DEVICE USER MANUAL

EN

Device user manual for ZENEC media system

We are delighted that you have chosen a product from ZENEC.

Please read this operating manual before you start your new ZENEC system. In this device user manual you will find important instructions and information for the safe operation of the ZENEC system, and to help you make the most of its technical advantages.

All the information in this manual corresponds to the state at the time of going to press, and applies only to ZENEC systems in original condition. On account of possible updates to device software, the illustrations and features shown in this operating manual may be different from your ZENEC system. Differences in the information, illustrations or features cannot form a basis for any claims.

If you sell your vehicle with the ZENEC system still fitted, please ensure that this operating manual stays with the vehicle, and that any personal data like a phonebook stored in the device is deleted.

CONTENTS

SAFETY INSTRUCTIONS	04
TURN DEVICE ON AND OFF	05
ANTI-THEFT PROTECTION	05
MULTIFUNCTION STEERING WHEEL CONTROLS	06
Z-N326 (FRONT PANEL)	07
Z-N426 (FRONT PANEL)	08
MAIN MENU STRUCTURE	09
MAIN MENU ICONS	10
MEDIA AUDIO SOURCES	11
INPUT SOURCES	12
STATUS BAR	13
SEARCH AND INPUT FUNCTION	14
UKW (FM) RADIO	15
FM BAR GRAPH MODE	16
MANUAL FM STATION SEARCH	17
UKW SETUP (FM)	18
DAB+ RADIO SETUP (ONLY FOR Z-N426)	19
DAB+ ENSEMBLE AND STATION LIST (ONLY FOR Z-N426)	20
DAB+ SETUP (ONLY FOR Z-N426)	21
DAB+ STATIONS-PRESETS (ONLY FOR Z-N426)	22
USB / BT A2DP / IPOD (AUDIO) MEDIA	23
USB / BT A2DP / IPOD (AUDIO) MEDIA CONTROL AND OPERATION BAR	24
BT-MUSIC (A2DP)	25
IPOD (AUDIO)	26
PLAYLIST (AUDIO)	27
SMART PLAYLIST (AUDIO)	28
FAV PLAYLIST (AUDIO)	29
VIDEO MEDIA: HARDDISK	30
PLAYLIST (VIDEO)	31
HDMI	32
CAMERA	33
SMARTLINK DIRECT	34
SMARTLINK DIRECT CONTROL INTERFACE	35
SMARTLINK DIRECT CONTROL BAR ICONS	36
SMARTPHONE APP LINKING	37

BLUETOOTH (HANDS-FREE SYSTEM)	38
CONTROL AND OPERATION BAR (RIGHT)	39
DEVICE MANAGER	40
PAIRING	41
BLUETOOTH SETUP	42
BLUETOOTH STATUS BAR	42
ACCEPTING/ENDING INCOMING CALLS (VIA DEVICE)	43
OUTGOING CALL VIA NUMERIC PAD	43
OUTGOING CALL VIA PHONEBOOK	43
BLUETOOTH MENU	44
PHONEBOOK	45
CALL LISTS	46
FAVORITES	47
NAVIGATION	48
NAVIGATION UPDATE	48
MAPS (EXAMPLES)	49
SETUP OPERATIONS	50
DISPLAY ICON (BRIGHTNESS)	51
SETUP OF SOURCES	52
BT / NETWORK SETUP	53
MISC SETUP	54
AUDIO SETUP	55
VOLUME SETUP	56
QUICK AUDIO SETUP (BAL/FAD_SUBWOOFER_LOUDNESS_BASS BOOST)	57
AUDIO SETUP: EXPERT MODE	58
AUDIO VOLUME – BASE LEVEL SETUP	59
BALANCE / FADER	60
EQUALIZER	61
X-OVER SETUP	62
SUBWOOFER SETUP	63
NAVI-MIXER SETUP	64
TFT DISPLAY CONFIGURATIONS	65
CAR (VEHICLE) SETUP	66
INPUT SETUP	67
SYSTEM SETUP	68
SOFTWARE VERSION	69
CLOCK TIME	70
PASSWORD	71
INSTALLATION NOTES	72
REMOVAL WORK AND PREPARATION	72
OVERVIEW ACCESSORIES	73
COMMISSIONING	73
CONNECTION DIAGRAM Z-N326 AND Z-N426	74-75
ABBREVIATIONS	76
STATUTORY RIGHTS AND WARRANTY	77

SAFETY INSTRUCTIONS

CAUTION

If the driver of the vehicle is distracted, this may lead to an accident or injury. Operating the ZENEC system can distract attention from the general traffic situation! Equally, connecting, changing or inserting data media can distract the driver from the general traffic situation.

CAUTION

Always choose loudspeaker settings such that acoustic signals coming from outside can always be heard in the vehicle (e.g. signal horns or sirens).

CAUTION

Incorrect installation or commissioning of the ZENEC system may cause damage to the ZENEC system or to the vehicle electronics. Only let qualified specialists authorized by ZENEC install the device.

CAUTION

This ZENEC system is intended solely for operation at an on-board voltage of 12 V DC. Operating the ZENEC system at any other voltage can cause damage to the ZENEC system or to the vehicle electrical system.

CAUTION

Taking apart or modifying the ZENEC system can result in damage to the device or the vehicle. Opening the device or modification by a person not authorized by ZENEC will render warranty claims null and void.

In the event of a malfunction or defect please contact an authorized ZENEC dealer. Unauthorized repairs will render warranty claims null and void.

CAUTION

The connection and charging leads of external mobile devices can get in the way of the driver. Please run these so that the driver's freedom of movement is not hindered.



CAUTION

Route recommendations and displayed traffic signs on the ZENEC system may differ from the real situation. Traffic signs and traffic regulations have precedence over route recommendations and indications of the ZENEC systems.



Speed data displayed in the navigation system corresponds to the permitted speed limit. Please adjust your speed and driving behavior to the prevailing visibility, weather, road, and traffic conditions.

TURN ON / OFF

Manual On / Off Z-N326

 Press the ZENEC button (fig. S/7 ) to turn the ZENEC system on, press and hold the ZENEC button to switch off the device.

Manual On / Off Z-N426

 Press the ZENEC button (fig. S/8 ) to turn the ZENEC system on, press and hold the ZENEC button to switch off the device.

Automatic On / Off

Vehicles without CAN bus:

The device automatically switches on/off by ignition signal.

Vehicles with CAN bus interface:

Switching on the ignition will activate the ZENEC system. The boot process can take up to 1.5 minutes. This may result in some delay until the system is ready. The ZENEC system is shut down by switching off the ignition, or removing the ignition key.

NOTE

Use of the multifunction steering wheel and other vehicle functions will require a vehicle-specific CAN/Stalk interface. Further information may be obtained from an authorized ZENEC dealer.

ANTI-THEFT PROTECTION

The ZENEC system is equipped with an anti-theft protection function. If this is active, on restarting the ZENEC system after interruption of the power supply you will be asked to enter your password.

To change the password:

Device User Manual → Setup → Device Setup → Password

NOTE

Keep your password safe. If the password is lost the ZENEC system must be uninstalled, and sent back in to ZENEC Service to unblock the anti-theft protection. This service is not free!



SECURITY CODE / SICHERHEITSCODE



MULTIFUNCTION STEERING WHEEL

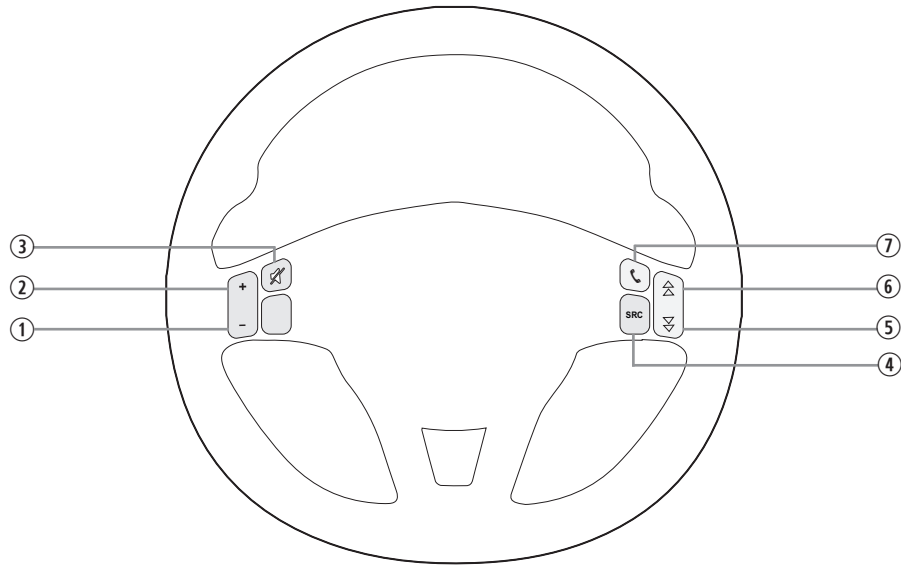

Item	Function	
①	Reduce volume	
②	Increase volume	
③	Mute	
④	Change playback source	
⑤	Radio source	Press to choose the previous radio station
	Media source	Press to choose the previous next track/title Press and hold to fast rewind.
⑥	Radio source	Press to choose the next radio station
	Media source	Press to choose the next track/title Press and hold to fast forward
⑦	Accept/end call	

i NOTE

These functions can only be used when a multifunction steering wheel is present in the vehicle, and the ZENEC system is connected via a car specific CAN/Stalk interface.

Z-N326 (FRONT PANEL)

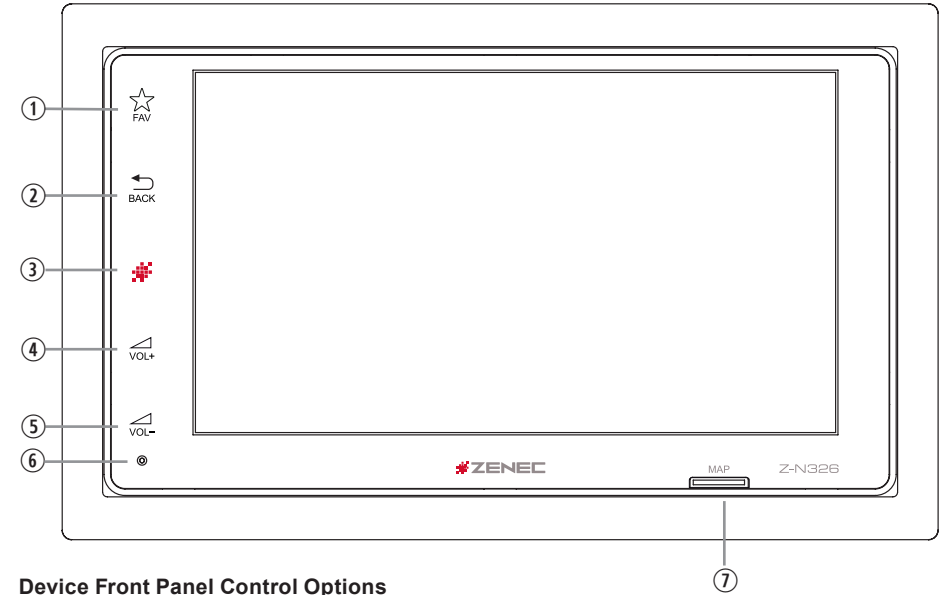

Device Front Panel Control Options

Item	Icon	Function
1		Tap to select preferred content or execute a function Press and hold to jump to audio settings
2		Tap to jump one level up or back
3		Tap to jump back to main menu Press and hold to turn device ON or OFF
4		Tap, or press and hold to increase playback volume
5		Tap, or press and hold to decrease playback volume
6		Hole in the glass panel for the reset pin
7		Slot for the microSD with GPS navigation software

Z-N426 (FRONT PANEL)

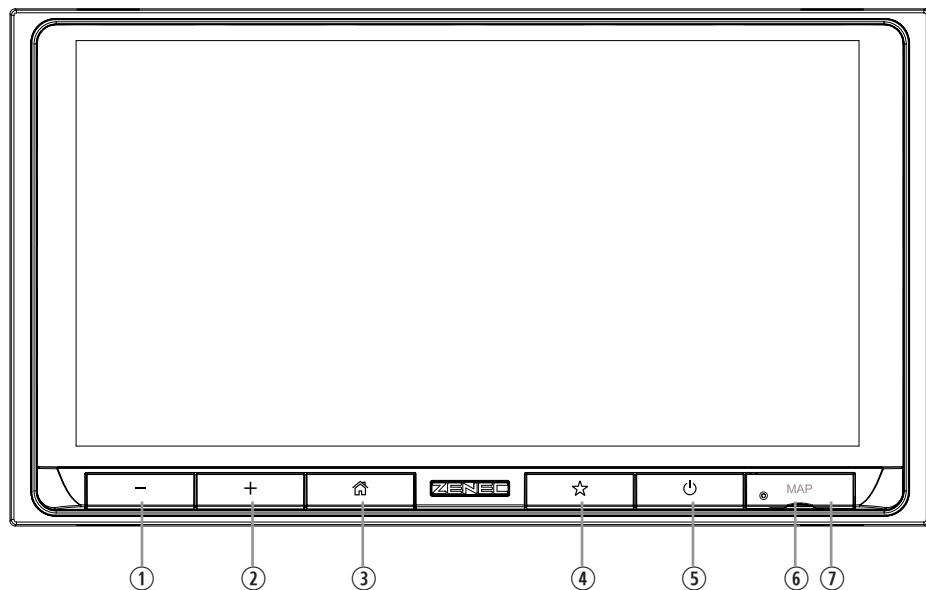

Device Front Panel Control Options

Item	Icon	Function
1	—	Press, or press and hold to decrease the playback volume
2	+	Press, or press and hold to increase the playback volume
3	🏠	Press to jump back to main menu
4	☆	Press to select preferred content or execute a function Press and hold to jump to audio setup
5	🔌	Press to mute device, press and hold to turn device ON or OFF
6	🔧	Reset pin to perform hardware reset behind the “MAP” cover
7	MAP	microSD card port for GPS navigation software behind „MAP“ cover

MAIN MENU STRUCTURE

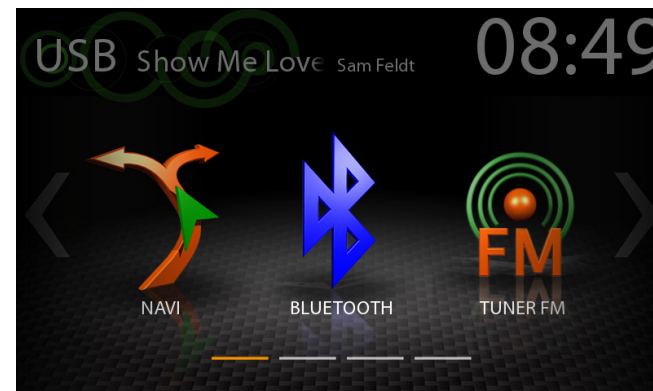

Main menu with 3 Icons



Main menu with 6 Icons

The icon amount show per main menu page can be adjusted in the setup (see page 54 „Main Menu Style“).

Display – touch sensitive operation Bedienung

Function	Icon	Operation
Sliden	👉👈	Swipe to navigate in the main menu by sliding to the left or right
Move	👉📍	Press and hold to move an icon into the desired position

MAIN MENU ICONS

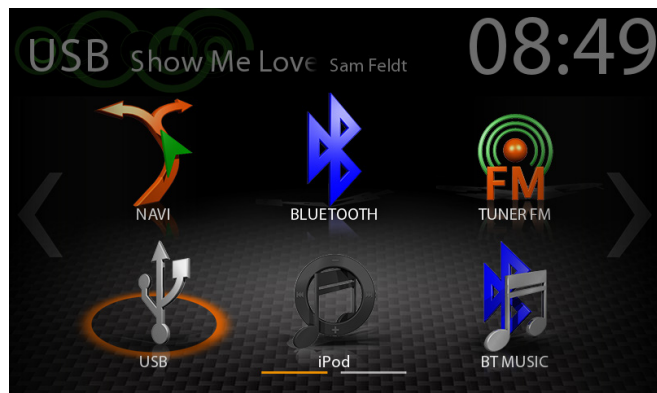

You can navigate through main menu pages by swiping or tapping on the orange page markers in the bottom area of each page.

Function	Icon	Operation
Navi		Tap to open navigation App
Bluetooth		Tap to open the Bluetooth suite
Tuner		Tap to open FM radio source
USB		Tap to enter USB source
iPod		Tap to open audio playback source (Apple)
BT-Music		Tap to open BT-Music source
DAB+		Tap to open DAB+ radio source (only for Z-N426)

MEDIA AUDIO SOURCES



You can access / enter connected internal or external sources by tapping on the main icon according to the following list.

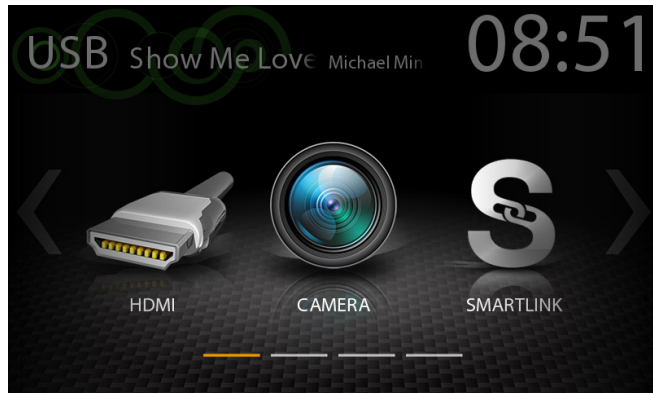

Function	Icon	Operation
USB		Tap to enter USB source
iPod		Tap to open audio playback source (Apple)
BT-Music		Tap to open BT-Music source
Smartlink		Tap to open Smartlink App
Tuner FM		Tap to open FM radio source
DAB+		Tap to open DAB+ radio source (only for Z-N426)
HDMI		Tap to open HDMI source

INPUT SOURCES



To select and open external sources like HDMI, Camera or Smartlink, they need to be paired or physically connected to the device.

Input Sources

Function	Icon	Operation
HDMI		Tap to open HDMI source
Camera		Tap to enter camera source
Smartlink		Tap to open Smartlink App



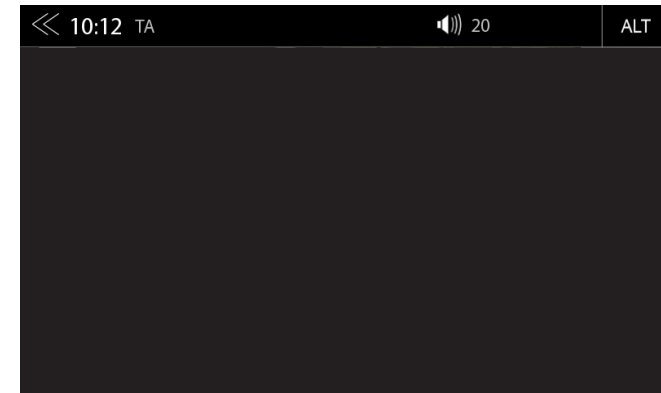

i NOTE

Icons in the main menu remain greyed out for sources not connected to device.

STATUS BAR ("INFO BAR")

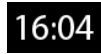

The „info bar in the upper hand screen area shows TA, volume and time but also contains two important controls for device operation: BACK (left side) and ALT (right side).

Function	Icon	Operation
Back		Tap to jump one level up or back
Clock Time		Display of time (no interaction possible)
Traffic Announcement		Traffic announcement (if function is set to active)
Volume		Shows the current playback volume
ALT		Tap to select / start a previously assigned function Settings → Misc → ALT Softkey button

SEARCH AND INPUT FUNCTION

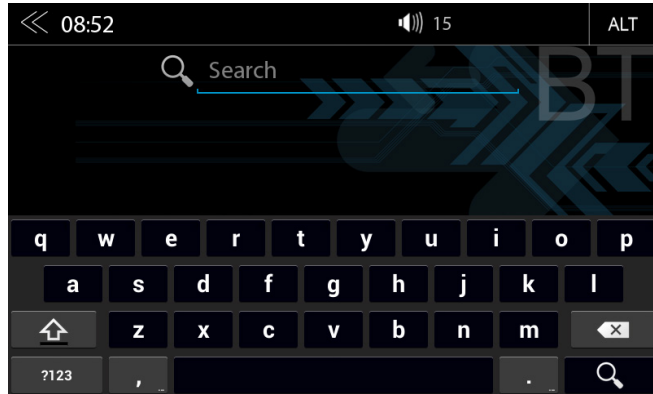

The keyboard for search and input is based on the Android OS system layout. The system language selection will automatically assign QUERTY or QWERTZ layout.

Function	Icon	Operation
Search		Tap to show or hide the actual input & search results
Delete		Tap to delete a number, letter or sign
		Press and hold to delete the full string
Back		Tap to end the search or the input
Large / Small		Tap to select small / capital letters for entries
		Tap twice to write all letters or numbers in capital style
List view		Tap to show all search results/- full list

UKW (FM) RADIO



The FM RDS source menu offers a control-/operating section on the right hand side, for fast and convenient adjustments during the FM radio playback.

Center Section of Display

Function	Icon	Operation
Station forward		Tap to start the auto FM station search, running up in the frequency band
Station		Station Name / Station Frequency
Station back		Tap to start auto FM station search, running down in the frequency band
Cover		Shows radio station graphics or cover picture of artist
Info display area		Finger swiping left and right to access stored FM stations previous / next

Control- and Operating Section

Function	Icon	Operation
Info		Tap to show station information
Frequency Scale		Tap to open FM station frequency bar
Preset		Tap to show the stored FM station list
Tuner Setup		Tuner settings
TA		Tap to activate or de-activate the auto switching of RDS traffic announcements

FM BAR GRAPH MODE

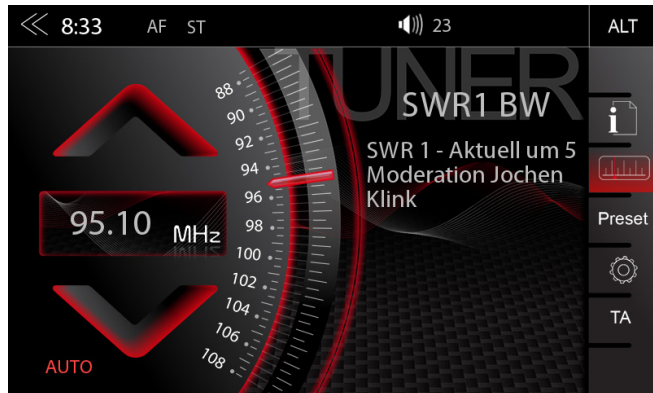

The FM setup mode (press gear icon) allows to assign two different operation modes to both station frequency arrows: manual steps in 100kHz, or auto scan (stopping at next station). See page 18.

Function	Icon	Operation
Station Frequency UP		Tap to start manual 100kHz jump, or FM station auto search up
Station Frequency		Tap to open the direct frequency input mode keyboard
Station Frequency DOWN		Tap to start manual 100kHz jump, or FM station auto search down
Bar Graph Scale		Press and hold to slide the frequency pointer of the bar graph into any position. Tap to set a desired frequency value on the scale

MANUAL FM STATION SEARCH



When you tap to the frequency display area, the numeric input keyboard opens for a direct station frequency input.

Function	Icon	Operation
Station Frequency UP		Tap to auto seek / manual seek up, depending on setting
Station Frequency		Tap to open and close direct station frequency input via keypad
Station Frequency DOWN		Tap to auto seek / manual seek down, depending on setting
Scale		Radio frequency scale display
Delete		Tap to delete a number Press and hold to delete the full text string
Keypad		Direct frequency input option
OK		Touch to confirm frequency

Control- and Operating Section

Information		Tap to show station information
Frequency Scale		Tap to open FM station frequency bar
Preset		Tap to show the stored FM station list
Tuner Setup		Tap to change settings for Tuner FM
TA		Tap to activate or de-activate the auto switching of RDS traffic announcements

UKW SETUP (FM)

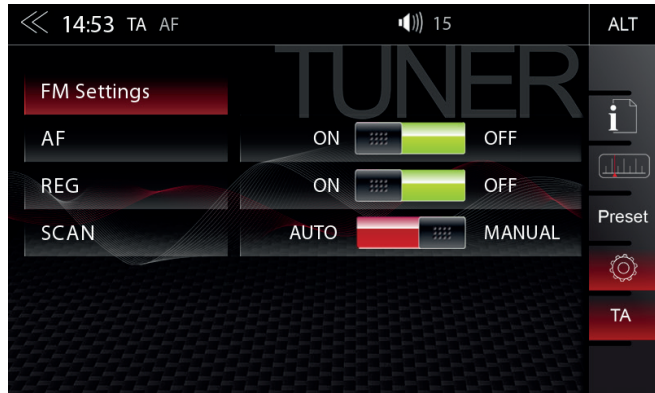

Here you can set important FM RDS based settings such as AF and REG.

Function	Icon	Operation
AF		Alternative Frequency ON / OFF
REG		Setting to keep AF in the regional (local) station tuning mode.
SCAN		Setting to choose the automatic or manual station frequency search.
TA		Tap to activate or de-activate the auto switching of RDS traffic announcements

DAB+ RADIO SETUP (ONLY FOR Z-N426)

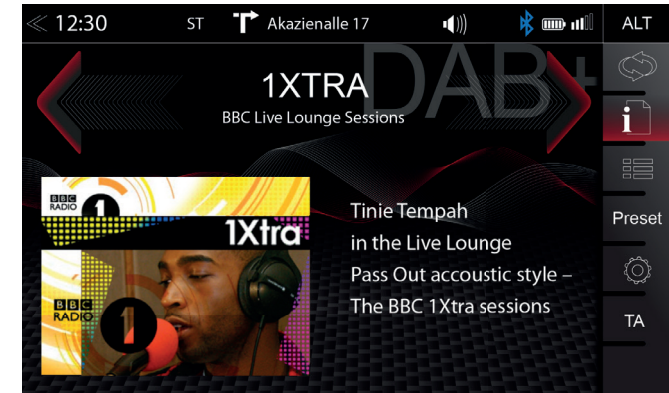

The DAB+ source menu offers a control- + operating section on the right side of the display, allowing for simple and convenient direct adjustments in the playback menu.

Function	Icon	Operation
Station up		Tap to jump to next station Press and hold to jump to next Ensemble
Station		Station Name / Ensemble info
Station down		Tap to jump to previous station Press and hold to jump to previous Ensemble
Slideshow		Radio station artwork / artist display ("MOT Slideshow")
Info Display Area		Finger swiping left and right to switch between Preset stations

Control- and Operating Section

Function	Icon	Operation
UKW / DAB+ Switch		Tap to switch between FM / DAB +
Info		Tap to show station information - main display
List		Tap to open the station list (showing all currently receivable radio stations in the environment)
Preset		Tap to show the stored DAB station list
Setup		Tap to change settings for DAB+ functions

DAB+ ENSEMBLE AND STATION LIST (ONLY FOR Z-N426)



Once the first DAB+ band scan has completed, device will show all DAB+ Ensembles and radio stations of sufficient signal strength. The Ensemble list and its content is auto updated periodically.

Function	Icon	Operation
Ensemble list selection		Tap to open an Ensemble, showing the assigned DAB+ radio station list
List scrolling		Press and hold to move the slider of the Ensemble list up and down
Back		Tap to jump one level back or up

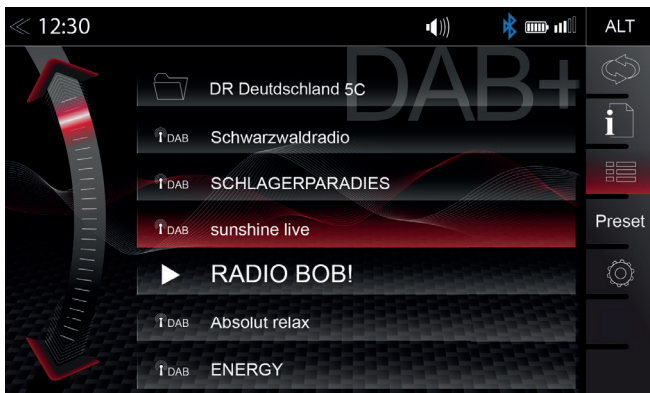

A tap on each Ensemble opens the related DAB+ station list of the respective Ensemble. The station list content follows exactly the original Ensemble display format and list sequence.

Function	Icon	Operation
Radio station selection		Tap to select one particular radio station out of the list
List scrolling		Press and hold to move the slider of the station list up and down

DAB+ SETUP (ONLY FOR Z-N426)

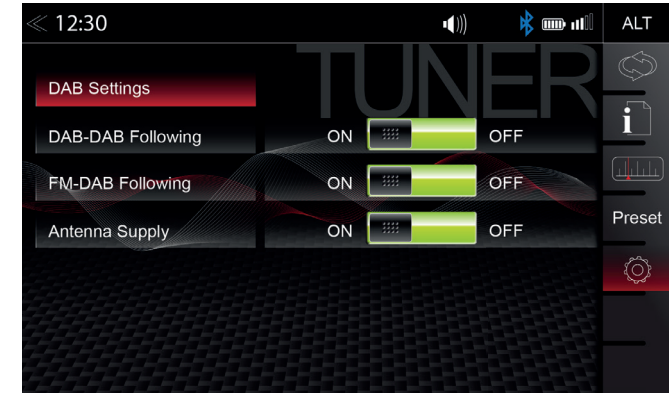

The setup page for the DAB+ tuner allows to define important functions such as DAB->DAB and FM->DAB station following. Or to activate the phantom power supply voltage of the DAB antenna socket.

Function	Icon	Operation
DAB-DAB Following		Tap to turn DAB-DAB station following ON or OFF
FM-DAB Following		Tap to turn FM-DAB station following ON or OFF
DAB antenna socket phantom power		Tap to turn the 12V phantom power supply of the DAB antenna socket on the device backside ON or OFF

NOTE

The FM-DAB Following function works with a static function algorithm. This may or may not deliver good switching results, depending on the broadcast region.

DAB+ STATIONS-PRESETS (ONLY FOR Z-N426)

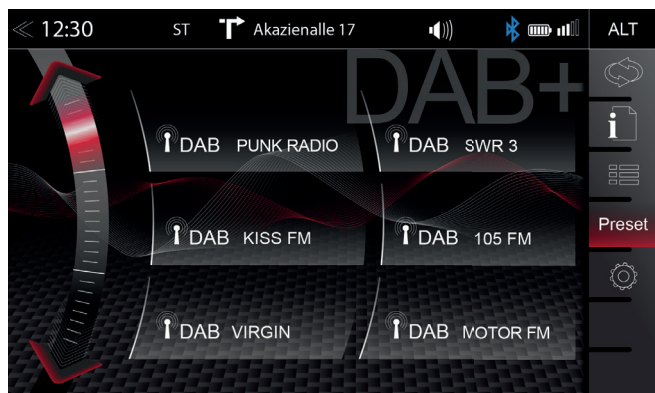

Select a previously stored DAB+ radio station by tapping on the station preset button.

Function	Icon	Operation
Previous page		Tap to switch to previous preset page
Next page		Tap to switch to next preset page
Stores		Tap to select a stored DAB+ station. Press and hold the station to save the actual radio station on any of the station preset buttons

USB / BT A2DP / IPOD (AUDIO) MEDIA

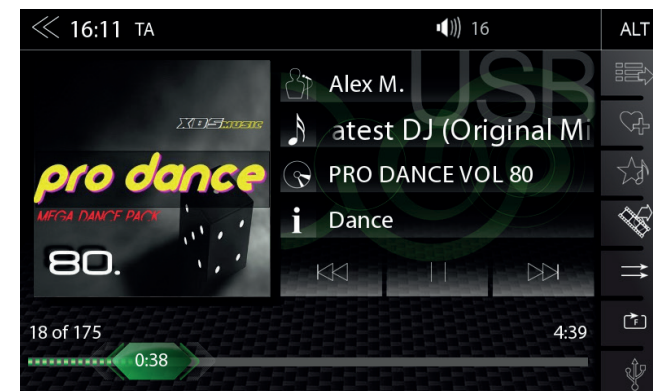

Various types of information shown in the source menu of the audio playback by (USB, BT A2DP, IPOD, etc.).

Function	Icon	Operation
Album, Art / Cover		If a cover is stored on the music media, it can be displayed. This function is not supported for BT Audio playback.
Interpret		Information about the artist
Track		Information about the track
Album		Information about the album
Genre		Information about the genre or any other special infos
Back		Tap to skip to the previous track Press and hold to start fast reverse
		Swipe to the left to skip forwards to the next track
Play		Tap to play a track
Pause		Tap to pause at a track
Forward		Tap to skip to the next track Press and hold to start fast forward
		Swipe to the right to skip back to the previous track
Playback Time Line		Tap or slide to skip within a track



The control and operation bar on the right side of the audio playback media menu continues to play lists, favorites, and external USB memory.

Function	Icon	Operation
Playlist		Tap to display the folder and list This function is not supported for BT Audio playback.
Smart Playlist		Tap to add a track to own playlist This function is not supported for BT Audio and iPod
Favorites		Tap to add a track to FAV playlist This function is not supported for BT Audio and iPod
Video <-> Audio Source		Tap to switch between audio or video playback. This function is not supported for BT Audio and iPod
Shuffle		Tap to turn on the random play feature within the folder that is playing
Repeat		Tap to automatically repeat a track or a complete music collection
Source		Touch to jump to next available source (Available sources USB, iPod and BT-Music)

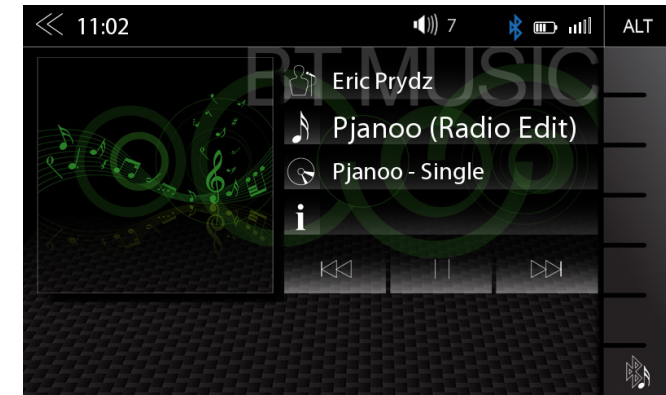

The A2DP RVC interface offers Play, Pause and Skip control of previously paired smartphones in audio playback mode. The iD3-Tag meta data display is possible only when tag data is contained in the streamed music track.

NOTE
The listed functions depend on the paired mobile phone, installed software versions and the degree of compatibility.

iPOD (AUDIO)

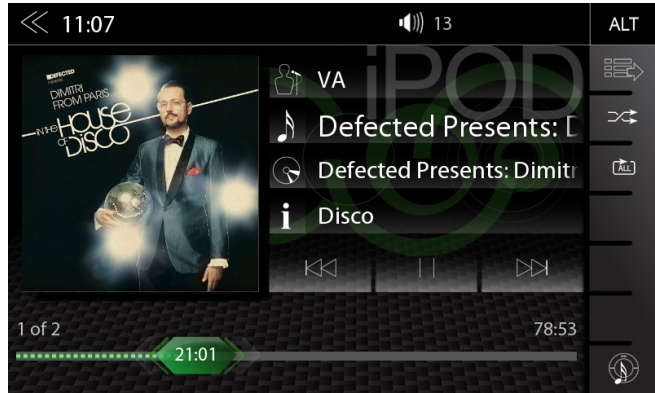

The order of the Artist display of is given by the sorting sequence on the mobile Apple device and can not be changed or adapted in any way.

PLAYLIST (AUDIO)









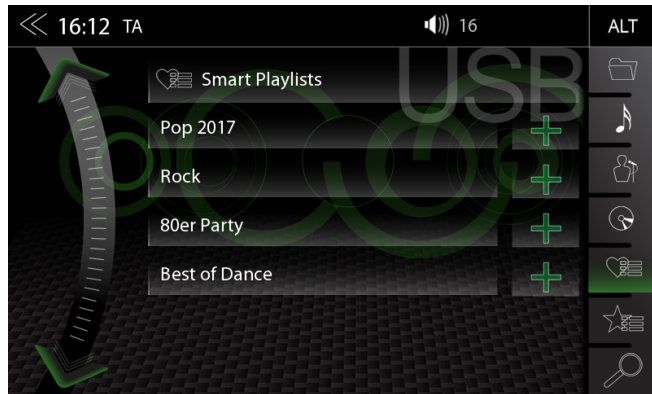



There are different playlists. We generally differentiate between the standard and special playlists (Smart Playlist and Favorites Playlist).

Function	Icon	Operation
Folder (uppermost)		Tap to go to the next higher level
Folder		Touch to go to the highest folder level Hold to go to the hard disk overview (root)
Song		Listing by song
Interpret		Listing by artist
Album		Listing by album
Smart Playlist		Tap to access the Smart Playlist (Shows created Playlists)
FAV List		Tap to access the FAV playlist
Search		Tap to open search keypad
Scroll		Scroll in the list: Touch and hold to move the slider up or down Tap and hold your finger on the list to move the list up or down

SMART PLAYLIST (AUDIO)

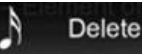



This function allows you to manage the playlists which created by the Smart Playlist function. The playlists can be renamed.

Function	Icon	Operation
Playlist name field		Tap to go to the next higher level
Playlist editing mode		Tap to edit a playlist (editing mode)
		Tap to delete a playlist
		Tap to rename a playlist
		Tap to cancel playlist edit mode
Song editing mode		Tap to edit a song within a playlist (editing mode)
		Tap to delete a playlist song
		Tap to move a playlist song (Add a song to another playlist)
		Tap to cancel edit mode
Scroll		Scroll in the list: Touch and hold to move the slider up or down Tap and hold your finger on the list to move the list up or down.

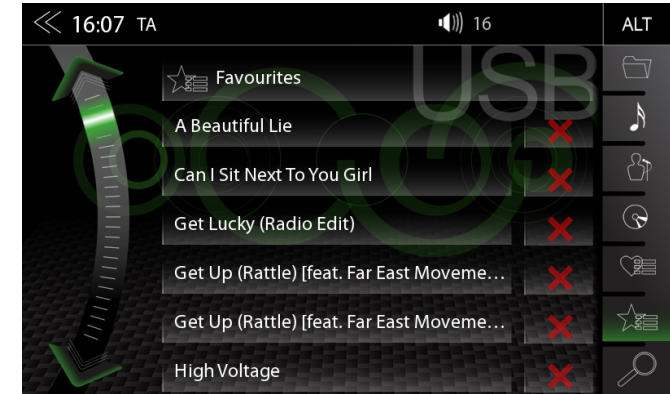
FAV PLAYLIST (AUDIO)



This playlist feature allows you to add a song easily and quickly to a fixed favorite playlist.

Function	Icon	Operation
Playlist name field		No function, text field only. Note: The name of the FAV playlist can not be changed.
Delete		Tap to delete a FAV playlist song
Scroll		Scroll in the list: Touch and hold to move the slider up or down Tap and hold your finger on the list to move the list up or down.

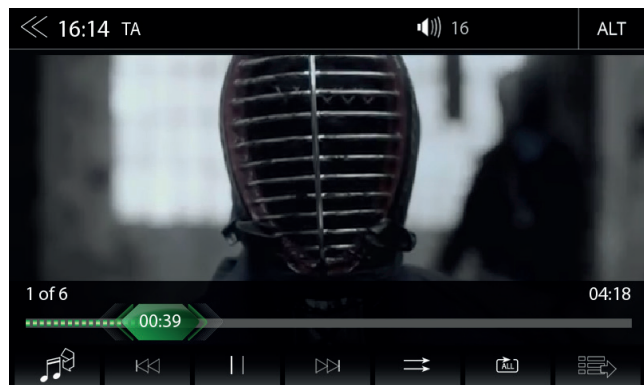

For video playback via USB, parking cable must be connected during the device installation. Without this connection, the screen remains black.

Function	Icon	Operation
Jump inside Title		Tap to skip directly to the desired position Slide to reach the desired position
Video<->Audio Source		Tap to switch between audio or video playback. This function is not supported for BT Audio and iPod
Back		Tap to skip back to the previous section
Play		Tap to play a film
Pause		Tap to pause a film
Forward		Tap to skip forward to the next section
Playlist		Tap to display the folder and list This function is not supported for BT Audio
Shuffle		Tap to turn on the random play feature within the folder that is playing
Repeat		Tap to automatically repeat a film or complete video collection

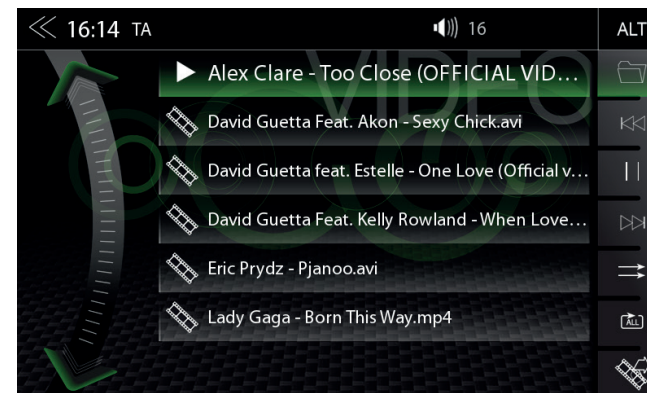

Playlist (Video) displays the video files on the USB data carrier with their file name. In this list sliding up or down is easily possible.

Function	Icon	Operation
Folder		Touch to go to the highest folder level Hold to go to the hard disk overview (root)
Back		Tap to skip back to the previous section
Play / Pause		Tap to play a film or a video Tap to pause a film or a video
Forward		Tap to skip forward to the next section
Shuffle		Tap to turn on the random play feature within the folder that is playing
Repeat		Tap to automatically repeat a film or complete video collection
Video <-> Audio Source		Tap to switch between audio or video playback. This function is not supported for BT Audio and iPod
Scroll		Scroll in the list: Touch and hold to move the slider up or down Tap and hold your finger on the list to move the list up or down

CAUTION

Playing video files while driving is not permitted by the law. For this reason the screen will switched off when the vehicle moves, with the playback of sound only.

HDMI

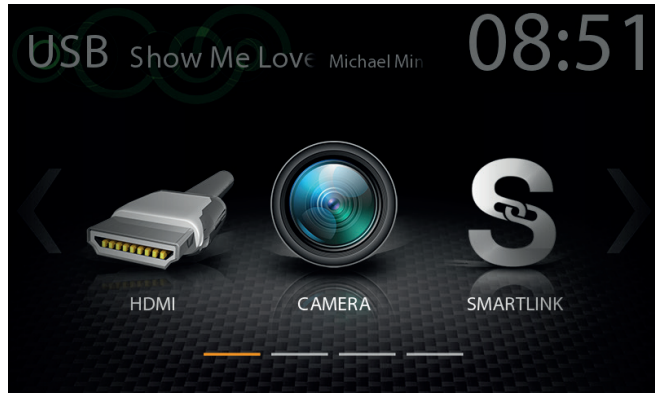



Tap to the HDMI icon starts the A / V source, if a compatible HDMI source connected, for example a videogame, smartphone, tablet, notebook.

Function	Icon	Operation
HDMI		Tap to open HDMI source mode

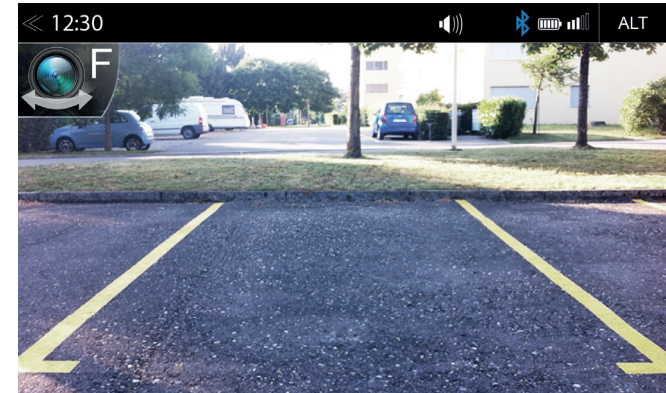
CAMERA



Tapping the camera icon starts the manual camera mode, if a CVBS capable camera is connected to the camera input of the unit.

Function	Icon	Operation
Camera switching		Tap to switch between the front and rear camera
Camera		Tap to open camera source

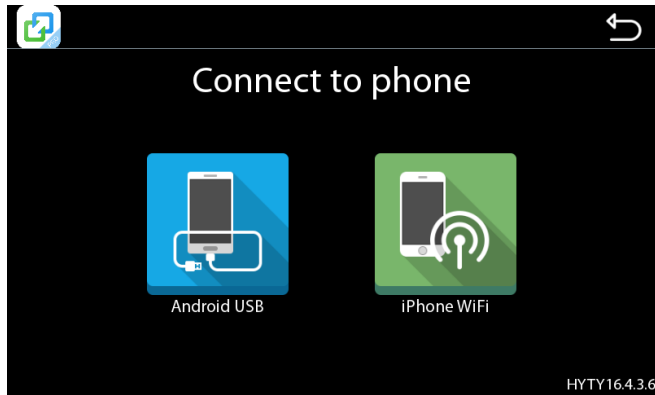

When a compatible smartphone is connected to the device via USB port, tapping on the Smartlink Direct main icons open the pairing options of the smartphone, or the display mode if the phone has been successfully paired before.

Function	Icon	Operation
Smartlink Direct		Tap to enter the Smartlink Direct mode

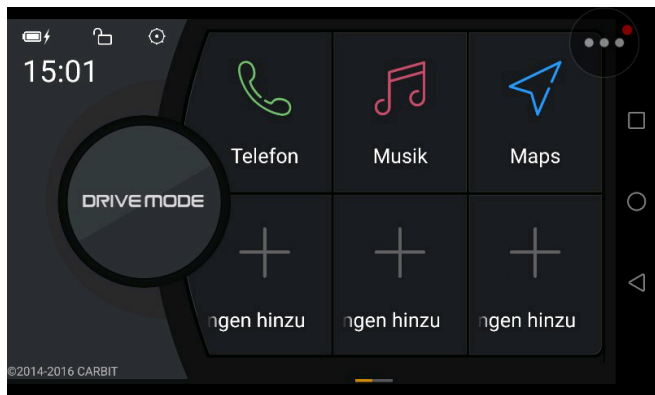

The Drive Mode control interface offers several options to configure and operate this App on the device, including the control of smartphone functions. See the three icons in the right hand side vertical area, which target operation and control of the (paired + connected) smartphone.

Function	Icon	Operation
Smartlink Direct Drive Mode Control Panel Button		Tapping on this circular button opens five control icons. Press and hold this Smartlink Direct button allows to move it into any position on the display screen.

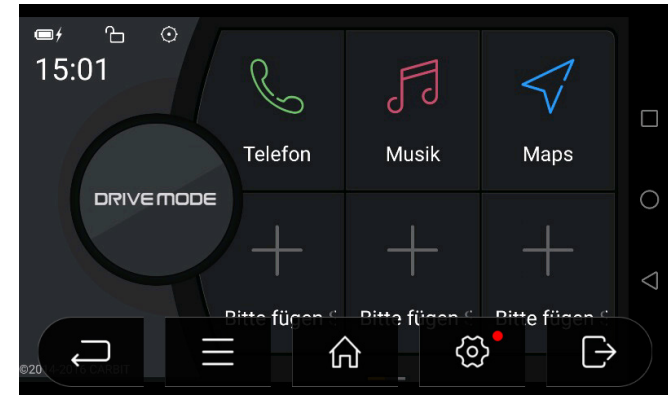

Function	Icon	Operation
Drive Mode Panel Back Icon		Tap to exit Drive Mode panel
Smartlink Control Bar Icon for menu control bar (to access Version info and display setup)		Tap to display infos and open display setup. See page 36.
Drive Mode Home Icon		Tap to jump back to main menu
Smartlink Setup Icon		Tap to open the Smartlink Direct setup page
Smartphone disconnect Icon		Tap to disconnect the smartphone and to jump back to smartphone select page
Battery Level and Charge Status icon		Shows battery level and charge status (no operation)
Drive Mode Icon to activate or lock screen rotation		Tap to activate screen (auto) rotation, or lock of screen rotation in dependency to smartphone
Smartlink Icon for menu bar		Tap to open menu bar
Display of Time		Display of Time (no operating function)
Smartphone Control Bar Icons to operate the connected smartphone (Icons and control logic may vary in accordance with connected smartphone model)		Tap to access/ open further functions of the connected smartphone

SMARTLINK DIRECT CONTROL BAR ICONS

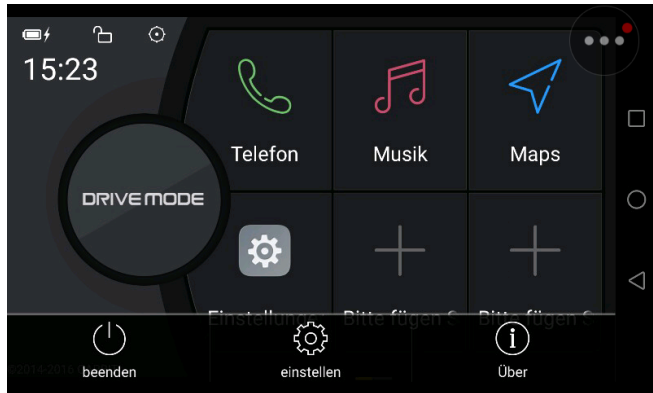

Smartlink Direct control bar to access versioninfo and display setup.

Function	Icon	Operation
Drive Mode ON/OFF Icon		Tap to close Drive Mode panel
Drive Mode Setup Icon		Tap to access Drive Mode setup
Version-Info (Software) Icon		Tap to show current software version info of the Smartlink Direct application installed on this device.

SMARTPHONE APP LINKING

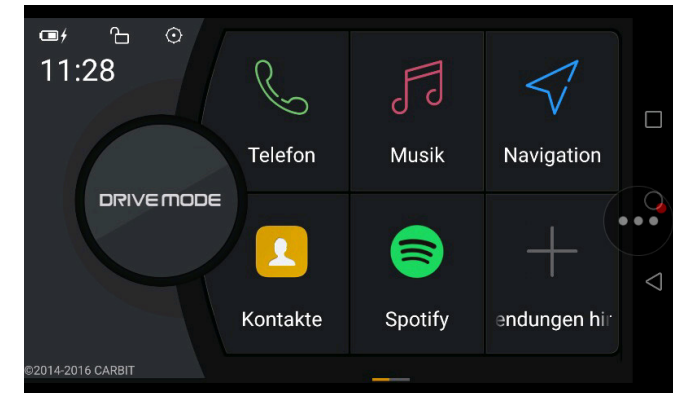

In the Drive Mode panel, you can link Apps on your smartphone to become a Smartlink Direct embedded function on the ZENEC device. Tap on the respective function field in the Drive Mode panel, where you want to assign a specific function. With the linked smartphone app, you can operate the app control functions directly via Zenec device (Android OS).

i NOTE

When a main system software update is installed on the device, the Smartlink Direct license will get overwritten (erased). The Smartlink Direct App will attempt to reload the UUID based license after a software update automatically. Make sure to connect a Smartphone right after the update has completed. Contact the ZENEC Support in case of Smartlink Direct function mishaps, after such an update.

BLUETOOTH (HANDS-FREE SYSTEM)

ABOUT THIS CHAPTER

This chapter describes how to operate and use the hands-free system. In addition, all the equipment variants and functions of the ZENEC BT system are described.

SAFETY INSTRUCTIONS

⚠ CAUTION

Using the mobile phone with the hand while driving is not permitted. Only enter data or make changes via the ZENEC system when the traffic situation allows such actions.

⚠ CAUTION

Network coverage depends on a number of factors – such as the network provider, or the geographical position of the vehicle. Tunnels, underpasses, parking garages, or street canyons in cities may lead to interruption of the connection. Thermal glazing or metallic stickers on the windows of the vehicle may also disrupt the connection.

CONTROL AND OPERATION BAR (RIGHT)



The vertical control and operation bar on the right area of the Bluetooth page serves to invoke device manager, or access phone book, favorites, call logs, numeric keypad, Bluetooth settings and Scan (BT device search).

Function	Icon	Operation
Device manager		Tap to access the device manager view
Phonebook		Tap to access the phonebook of the currently paired mobile phone
Favorites		Tap to access the stored favorites
Call logs		Tap to access the call logs
Numeric pad		Tap to open the numeric keypad
Bluetooth setup		Tap to change the most important settings for BT operation
SCAN (Search)		Tap to search a new Bluetooth device

DEVICE MANAGER

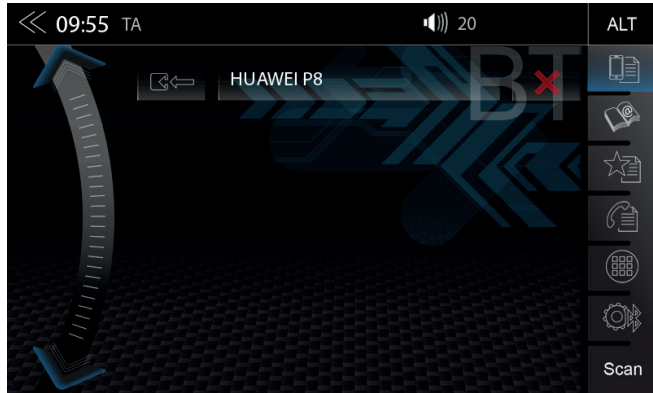

The BT function on the device must be activated to invoke connection process. Please pay attention to the smartphone manufacturer's instructions regarding device pairing.

Function	Icon	Operation
Device manager		Tap to pair, disconnect, or manage mobile devices

Function	Icon	Operation
Pair		Tap to reconnect a paired Bluetooth device
Disconnect		Tap to disconnect a paired Bluetooth device
Delete		Tap to delete a Bluetooth device from the list (requires the device to be disconnected)

Icon	Meaning
	This icon indicates that the paired Bluetooth device supports HSP/HFP, and can be used via the hands-free system.

PAIRING

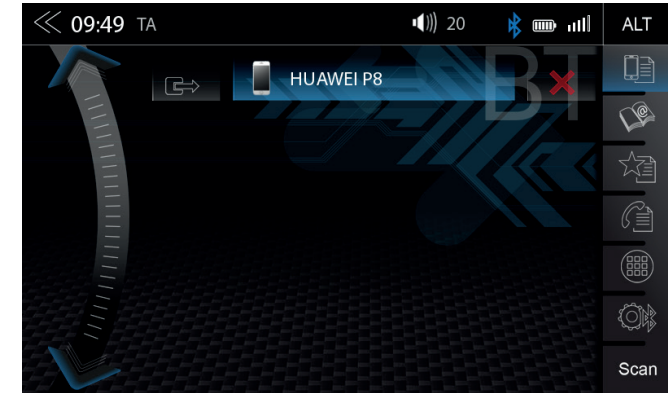

To connect a smartphone to the Zenec device via Bluetooth, first step is to successfully complete the pairing process.

Via ZENEC system

Function	Icon	Operation
Scan (Search)		Tap to the SCAN icon to initiate a search for BT devices. From the list select the desired mobile device that you want to synchronize with the ZENEC system. Once device is selected, follow the instructions.
Code		Standard Code*: 0000 (PAIRING Code can be changed in Bluetooth Settings – Set Pin, see Page 42)

i NOTE

*For mobile devices that do not support the SSP standard

Via the mobile device

Function	Icon	Operation
Search		Make sure that the ZENEC system is in Device Manager view otherwise the ZENEC system will not be visible to others. Follow the instructions of the device manufacturer on pairing.

Auto Connect

Once a mobile device has been connected with the ZENEC system, it will be automatically paired when the ZENEC system is started. On being briefly disconnected the ZENEC system will attempt to establish a new connection.

i NOTE

On pairing for the first time, be sure to permanently enable the connection confirmation on your mobile device, otherwise malfunctions may occur during the Auto Connect process.

BLUETOOTH SETUP

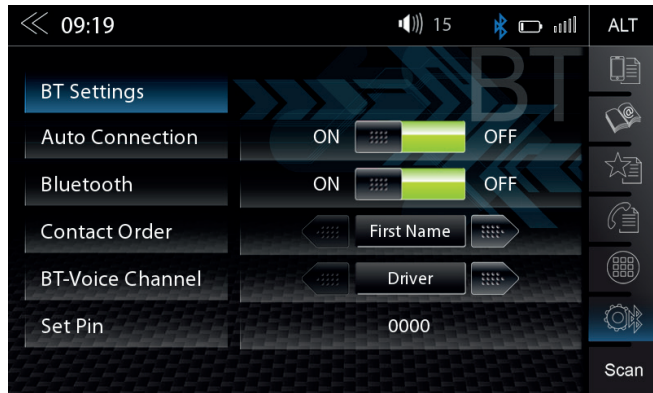

On the Bluetooth setup page you can adjust settings for Bluetooth operation. Press the appropriate button / field to change any of the listed settings.

Function	Icon	Operation
Bluetooth Settings		Tap to change settings for BT operation
Auto Connection		ON / OFF
Bluetooth		ON / OFF ON = Bluetooth module activated OFF = Bluetooth module deactivated
Contact Order		1. by first name 2. by surname
BT-Voice Channel		1: Driver: The call is exclusively on the driver side. 2: Front: The call is complete on both sides t. (in the entire front area)
Set Pin		Tap to change Bluetooth code (Pairing PIN) Standard code: 0000

BLUETOOTH STATUS BAR

Icon	Function
	Mobile phone currently connected
	Battery capacity of the mobile phone currently connected
	Signal strength of the current mobile network

ACCEPTING/ENDING INCOMING CALLS (VIA DEVICE)

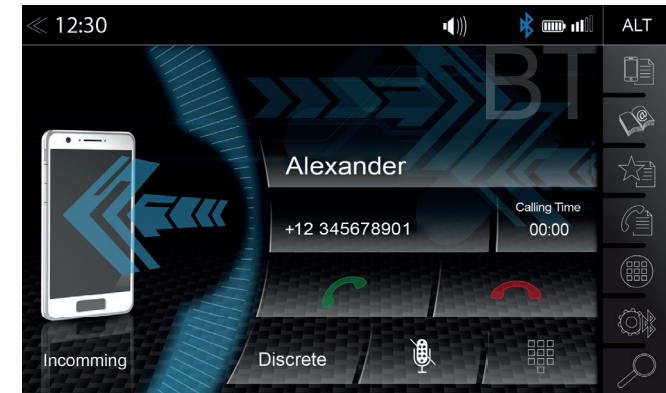

Function	Icon	Operation
Accept		Tap the green handset to accept the call
Reject		Tap the red handset to reject the incoming call
End		Tap the red handset to end the call

DIAL A CALL USING NUMERIC PAD

In the control-/operation panel touch the numeric pad.
Key in the desired phone number in full using the numeric pad. To set up the connection, touch .
The display now changes to the call connection view.





DIAL A CALL USING PHONEBOOK

In the control-/operation panel touch the phonebook.
From the phonebook list select a call partner and set up a connection by touching .
After touching a contact you will be directed to the contact details view.

i NOTE

Depending on the mobile phone and phonebook entries, the first synchronization can take up several minutes.

BLUETOOTH MENU

Function	Icon	Operation
Discrete		Touch to pass the call from the hands-free system to the mobile phone or vice versa
Mute conversation		Voice output muted/- unmuted
Numeric pad		Tap to show the numeric pad Necessary in case asked to enter a further number during the call (telephone call center etc.)
Back		Tap to jump back to the previous level

NOTE







To be able to use the phonebook or call lists without any problems, make sure that during the pairing process you confirm data access enable to the mobile phone.

PHONEBOOK

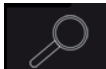
Contacts



After successful pairing of the smartphone with subsequent phone book synchronization, the device will show you the full contact list. You can add contacts directly to Favorites if you like.

Function	Icon	Operation
Search		Tap to open the contact search keypad
Scroll		Scroll in the list: Touch and hold to move the slider up or down, showing letters by the alphabet.
Phonebook Contacts		Tap to jump to the contact list. Up to 1000 contacts per paired mobile phone can be synchronized; it makes no difference whether the contacts are stored in the phonebook or on the SIM card.
Favorites		Tap to show phone numbers of the respective contact entry
Call / Accept		Tap the green handset to set up/- start the call
Add Favorite		Tap to add a new Favorite Re-tap to remove a Favorite

CALL LISTS

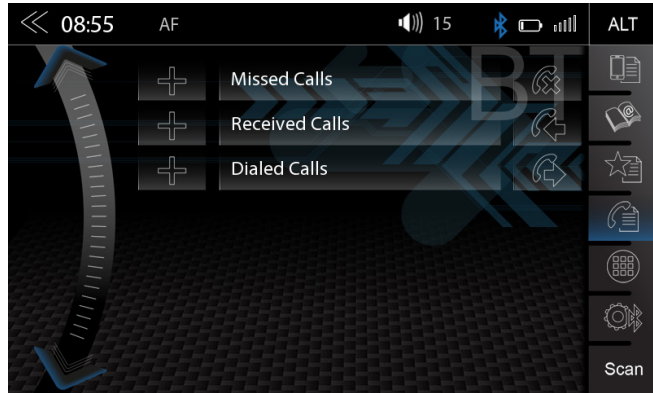

If a compatible mobile phone is connected, call lists from the mobile phone will be synchronized with the BT hands-free system (process can take some minutes, depending on the number of contacts). Once sync process has completed you will be able to access the following logs:

Function	Icon	Operation
Call logs		Tap to see all call logs
Missed Calls		Tap to see the missed calls only
Received Calls		Tap to see the received calls only
Dialed Calls		Tap to see the dialed (outgoing) calls only

Function	Icon	Operation
Missed		Entries with this icon refer to calls that you missed
Incoming		Entries with this icon refer to accepted incoming calls
Contacted		Entries with this icon refer to outgoing calls

FAVORITES

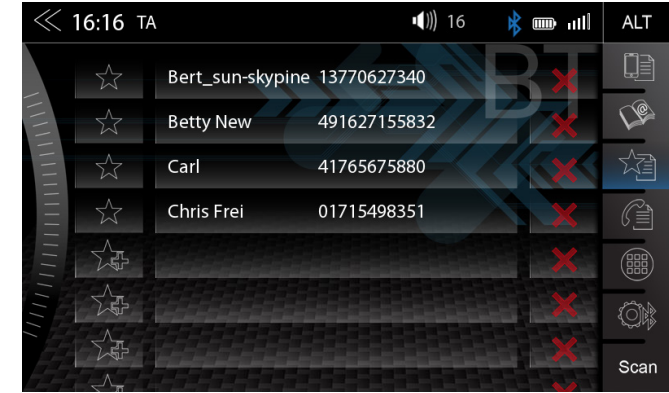

On this page you can link eight or more phone numbers to become favorites. You can select any of the phone numbers in the phonebook and save them as Favorites; the only exceptions are e-mails and addresses.

NOTE

All Favorites are visible to every user of the device as they are saved in device memory.

Function	Icon	Operation
Stored Favorite		Tap to set up/- start a connection with a stored Favorite
Assign New Favorite		<ol style="list-style-type: none"> Tap to add a new favorite Select desired number from phonebook and confirm with this ☆ icon
Delete		Tap to remove a stored Favorite

NOTE

A change of data on the mobile phone will not sync automatically with the stored Favorites. Should you want to change phone numbers this change must be manually transferred to Favorites by deleting the existing Favorite and re-assigning the new number.

NAVIGATION

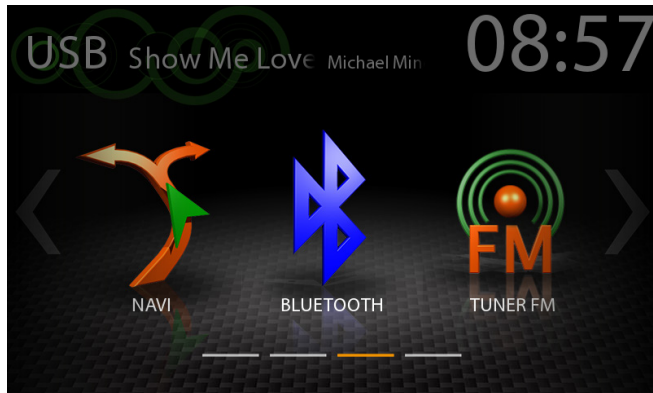

For the ZENEC devices Z-N326 and Z-N426 a navigation package is available separately. This bundle comes with multilingual Quickstart manual and navigation software on 8GB microSDHC card. The images shown on this double page, as well as instructions, are taken from this solution.

Function	Icon	Operation
Navigation		Tap to start navigation and show map view (Only if microSD card from the Z-N326-SDFEU or Z-N426-SDFEU package in the device)

NAVIGATION UPDATE

Activation of the free 12-month map software update period begins once the ZENEC system has been switched on and running over a distance of >10 km.

Requirements

1. PC or notebook with a Windows 7 operating system or higher, an SD card reader, together with broadband Internet access. Apple OS not supported.
2. An activated navigation map microSD card (set content)
3. Latest Naviextras Toolbox software, installed on your computer.
Download-Link: <https://zenec.naviextras.com/shop/portal/downloads>

To be able to update your ZENEC device with new maps, proceed as follows:

1. Go to <https://zenec.naviextras.com/shop/portal> and set up a user account with a password and the personal data for your navigation device.
2. Download the Toolbox Software: Naviextras Toolbox Download. Read through the application instructions before taking any further steps. The Toolbox is periodically updated. Therefore, should you want to make a map update at a later time, always download the latest Toolbox version. This will guarantee optimal compatibility of all data transfer functions.

i NOTE

Map updates can be carried out by visiting <https://zenec.naviextras.com/shop/portal>.
Safety instructions: see page 4.

MAPS



Fast and simple route calculation

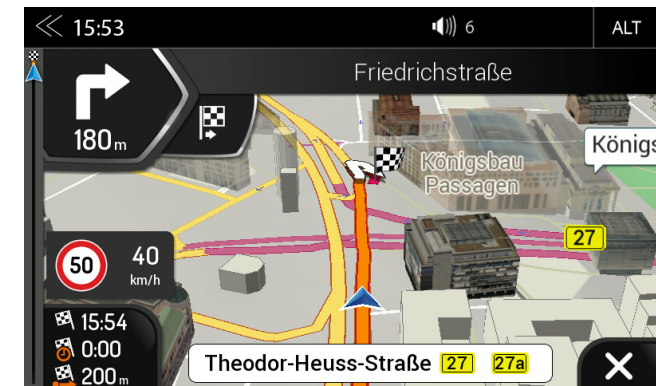

High resolution 3D maps

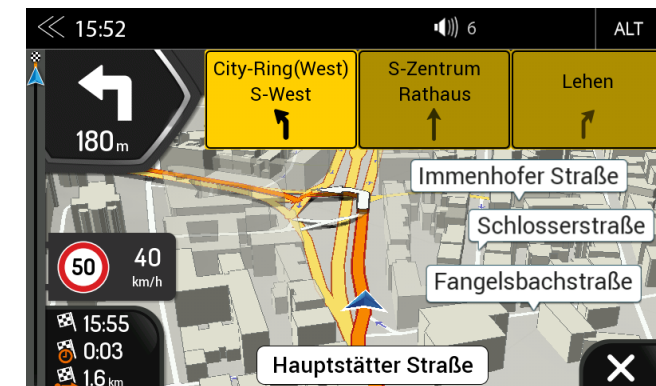

Advanced route guidance

SETUP OPERATIONS



This chapter describes all the parameter and setting functions of the ZENEC system. Please note that settings or changed parameters can have a direct influence on the everyday use of the ZENEC system.

Function	Icon	Operation
Setup		Tap to access the setup mode

i NOTE

Software updates applicable to this device, except navigation engine + map updates are free of charge. Download here: www.zenec.com/support/software-updates/

DISPLAY ICON







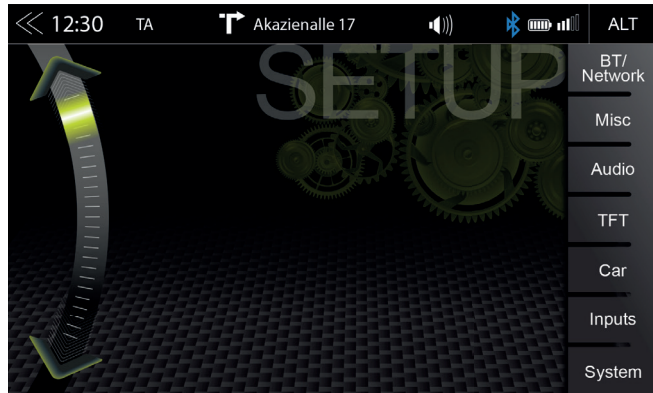

With the display icon, the LCD TFT screen picture brightness can be dimmed or switched off (standby) in two steps. This is done by tapping the icon.

Function	Icon	Operation
Disp		Tap to dim or brighten up TFT screen (↶ 100% → 50% → 0% "standby" ↷)

SETUP OF SOURCES







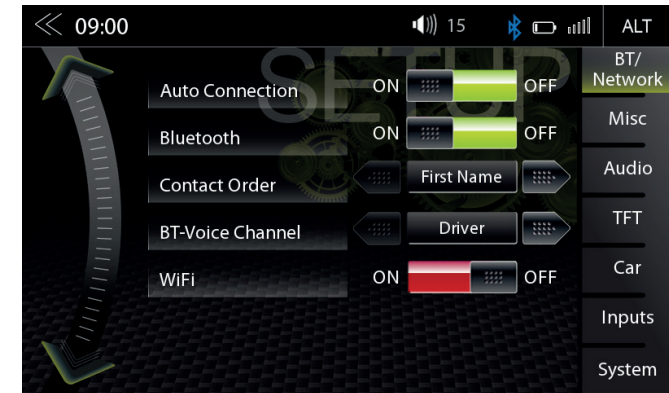

When you tap the setup icon, you will enter this setup source page, which offers six different sources you can adjust for personal preferences.

Function	Icon	Operation
BT/Network		Touch to access hands-free system settings Touch to access Network settings
Misc		Tap to access diverse device settings
Audio		Tap to access sound settings
TFT		Tap to access display settings
Car		Tap to access car settings (Park Assist etc.)
Inputs		Tap to access TFT inputs settings
System		Tap to access system settings

BT / NETWORK SETUP



In BT / Network Setup, you can make important settings for best Bluetooth operation. Tap on the ON / OFF button of desired field to effect a change.

Function	Icon	Operation
BT/Network Settings		Tap to change settings for BT operation
Auto Connection		ON / OFF
Bluetooth		ON / OFF ON = Bluetooth module activated OFF = Bluetooth module deactivated
Contact Order		1: by first name 2: by surname
BT-Voice Channel		1: Driver: The call is exclusively on the driver side. 2: Fornt: The call is complete on both sides (in the entire front area).
WiFi		ON / OFF ON = external WiFi dongle activated OFF = external WiFi dongle deactivated

MISC SETUP

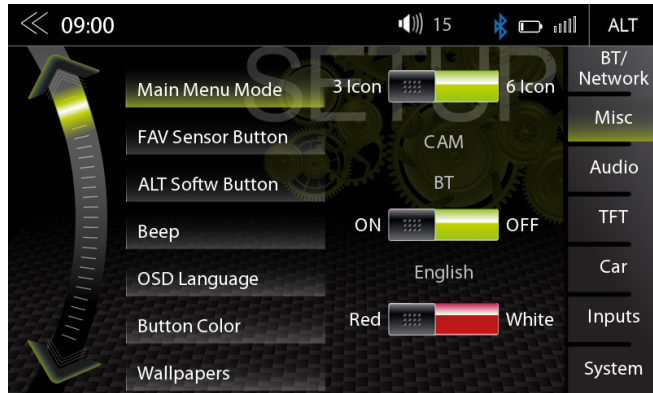

In the Misc menu page, you can configure diverse settings for the display mode with 3 or 6 icons, ON/OFF of the beep sound, as well as the LED color (white / red) of the lighting of the buttons or sensor buttons on the device front.

Function	Icon	Operation
Misc		Tap to access basic settings view
Main Menu Mode		Tap to switch to 3 Icon or 6 Icon main page display layout
FAV Button		Touch to link source or function to the FAV button: (CAM/Mute/NAVI/Tuner/EQ/Setup/BT-Music/BT/ DISP/iPod/USB/HDMI/ Smartlink Direct)
ALT Software Button		Touch to link source or function to ALT (HMI) button (CAM/Mute/NAVI/Tuner/EQ/Setup/BT-Music/BT/ DISP/iPod/ USB/HDMI/Smartlink Direct)
Button sounds		ON / OFF Off = acoustic acknowledgment disabled On = acoustic acknowledgment enabled
OSD Language		Tap to change the menu language
Button Color		Tap to alter hard key or sensor field illumination to Red or White color (ZENEC logo color cannot be altered)
Wallpapers		Tap to change the background image
Volume Pop-Up		ON / OFF Off = visual volume pop-up disabled On = visual volume pop-up enabled

AUDIO SETUP

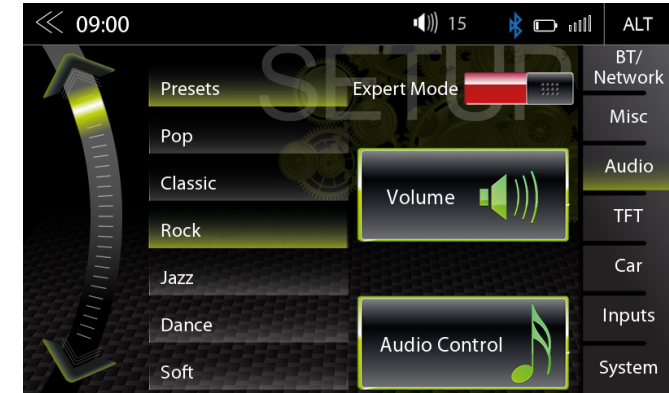



In the Audio menu page, you can adjust settings around the sound, e.g. Volume of the sources, loudness, bass and treble, etc.. The "Expert Mode" view extends the setting options by few points.

Function	Icon	Operation
Audio		Tap to access and configure audio settings
Presets		Tap on one of the presets to change profile (Pop / Classic / Rock etc.) All changes made in the Expert Mode at the Equalizer will be stored under the preset "User".
Expert Mode		Tap to enable or disable expert mode. Tap to make advanced sound configurations.
Volume		Tap to set initial and source volume levels
Audio Control		Tap to access quick audio settings (Loudness / Bass Boost etc.) This can also open by long pressing of the FAV button.

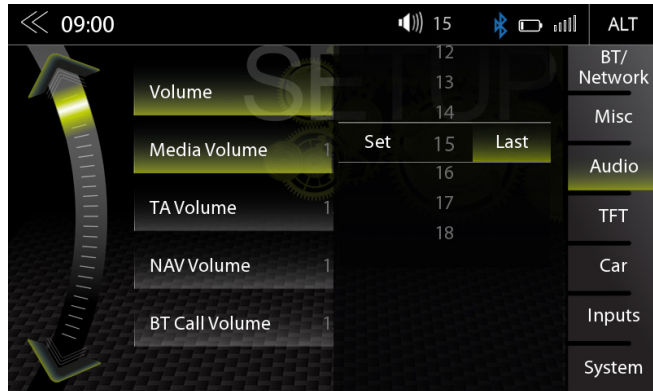
VOLUME SETUP



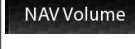
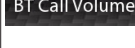

In the Audio menu -> Media Volume, you can customize the basic settings of each source individually.

Function	Icon	Operation
Media Volume		Main volume change requires upper setting position set to "Select". Setting = manually adjusted volume Last = last volume set before switching off
TA Volume		TA volume change requires upper setting position set to "Select". Setting = manually adjusted volume Last = last volume set before switching off
Navi Volume		NAV volume change requires upper setting position set to "Select". Setting = manually adjusted volume Last = last volume set before switching off
BT Call Volume		BT Call volume change requires upper setting position set to "Select". Setting = manually adjusted volume Last = last volume set before switching off

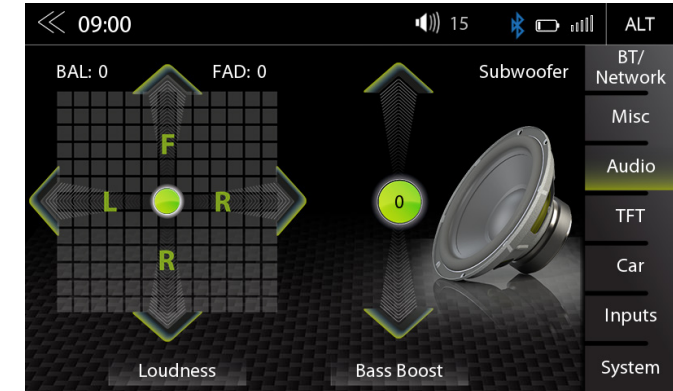
QUICK AUDIO SETUP (BAL / FAD / SUBWOOFER / LOUDNESS / BASS BOOST)

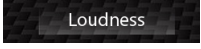
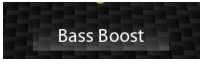
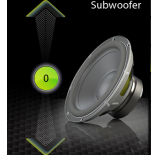

In this menu, you can adjust the Balance / Fader, Loudness, Bass Boost and Subwoofer level of the speakers in the vehicle.

Function	Icon	Operation
Left/ Right		$7L > 0 < 7R$
Front/ Rear		$7F > 0 < 7R$
Loudness		ON / OFF
Bass Boost		ON / OFF
Subwoofer		$-6 < 0 > 6$

AUDIO SETUP: EXPERT MODE



In the Audio Setup menu page with the Expert Mode set to “ON”, you can change audio relevant settings. Such as Equalizer, Crossover, Navi-Mixer, etc. Please refer to the listings on the following pages.

Function	Icon	Operation
Expert Mode		Tap to enable or disable expert mode
Volume		Tap to set start and source volume
Balance/Fader		Tap to set fader or balance
Equalizer		Tap to set the 10-BAND equalizer
X-Over		Tap to make settings for the crossover
Subwoofer		Tap to set subwoofer settings
Navi-Mixer		Tap to set navi voice output configuration
Audio Control		Touch to make general quick audio settings (Loudness / Bass Boost etc..) Can be accessed by long press of the FAV button.

Volume Setup: see page 56

AUDIO VOLUME – BASE LEVEL SETUP

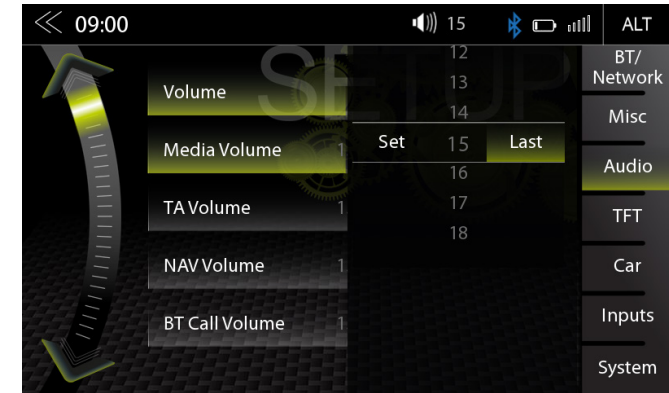

In the audio menu, you can adjust the basic volume values of the various audio sources.

Function	Icon	Operation
Volume		Tap to set the system main startup volume
Media Volume		Tap to set the media playback volume
TA Volume		Tap to set the volume of (FM RDS) traffic announcements
Navi Volume		Tap to set the volume of the Navi voice
BT Call Volume		Tap to set the volume of the Bluetooth handsfree volume

BALANCE / FADER

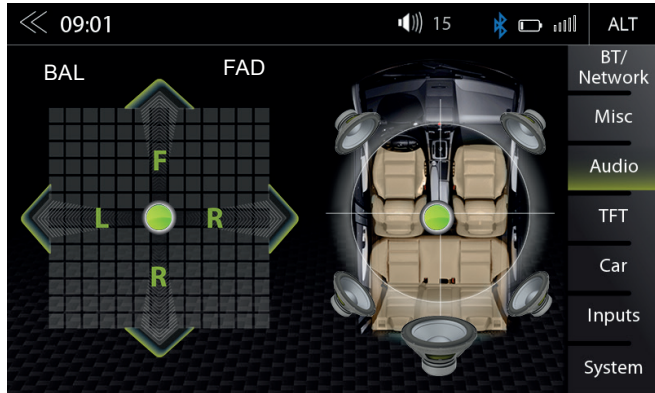

In this Expert Mode menu page, you can adjust the balance and faders. Press and hold the green dot of the crosshair to move sound center position into any desired position.

Function	Icon	Operation
Left/Right		7L < 0 > 7R
Front/Rear		7F < 0 > 7R
Crosshair		Press and hold to move green dot into desired position

EQUALIZER

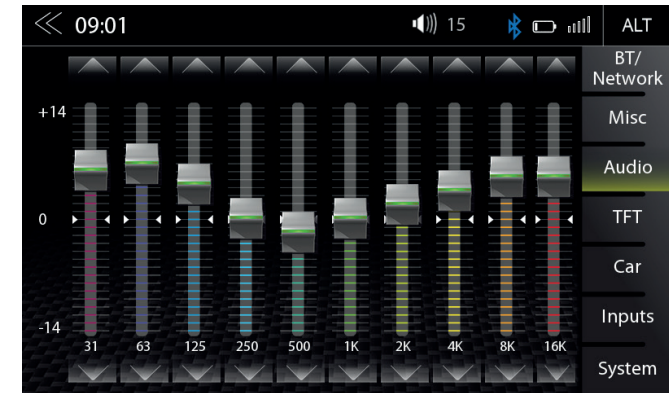



In this Expert Mode menu page, you can set the 10-band graphical equalizer. Press and hold the individual band level sliders to move it up or down for a level change.

Function	Icon	Operation
Band		Tap to set the desired BAND
		Touch and hold to change the setting of the selected band

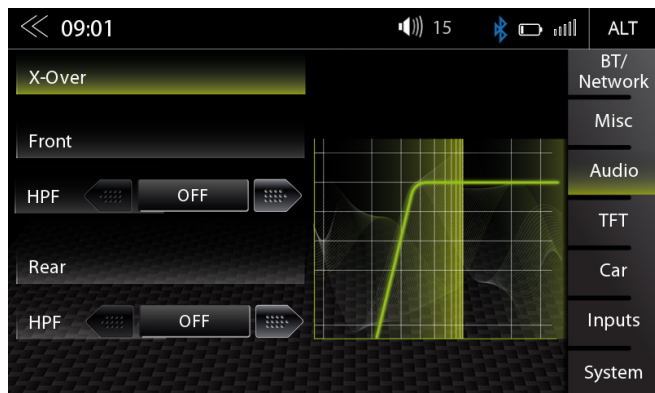
X-OVER SETUP



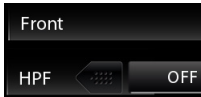



In this Expert Mode menu, you can adjust the High-pass transition frequencies of the front and rear speakers. The factory default is OFF for front and rear speakers.

Function	Icon	Operation
HPF (Front)		Tap to set the high pass filter OFF (FLAT)/65 Hz/80 Hz/100 Hz/125 Hz
HPF (Rear)		Tap to set the high pass filter OFF (FLAT)/65 Hz/80 Hz/100 Hz/125 Hz

SUBWOOFER SETUP



In this Expert Mode menu, you can adjust Phase, Gain, and Low-pass transition frequencies of the subwoofer. The default settings are Phase 0°, Power OFF, LPF OFF.

Function	Icon	Operation
Power		ONLY SUBWOOFER -Cinch Outputs (Affects the subwoofer line-out only) ON = Volume according to setting. OFF = Mute
LPF		Tap to set the low pass filter OFF 160 Hz/120 Hz/100 Hz/80 Hz/65 Hz
Phase		SUBWOOFER ONLY 0/180° (inverted phase)
Gain		Touch to set the GAIN -6 < > 6

NAVI-MIXER SETUP



In this Expert Mode menu page, you can adjust audio ducking or mute of audio and video source playback by nav route guidance voice. Secondly, you can adjust if the route guidance voice will be transmitted only via the left front speaker (driver side) or via both front speakers. Works only for ZENEC navigation software.

Function	Icon	Operation
Mute Media Sources for Navi Voice Announcement		ON / OFF OFF = Ducking of media playback during route guidance voice announcements ON = Media playback is fully muted during route guidance announcements
Navi Voice Channel		Driver = only at driver's speaker Front = only at speakers front left and right Driver / Front / All (conditional)

TFT DISPLAY CONFIGURATION

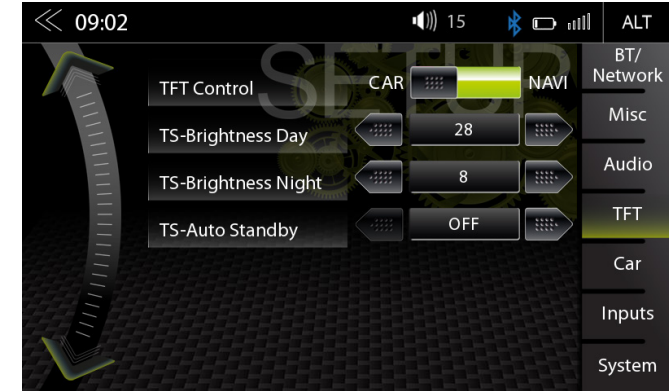

In the TFT Setup menu you can make screen settings that control the day/night brightness of the TFT LCD display screen. This will only work with 8GB microSD card from the ZENEC navigation software bundle (Z-N326-SDFEU or Z-N426-SDFEU).

Function	Icon	Operation
TFT configuration		Tap to adjust display configuration
TFT Control		Tap to select the brightness control: Navi = Day/Night brightness is controlled by the navigation system. Car = Day/Night brightness is controlled by vehicle illu voltage.
TS-Brightness Day		Day adj range 0 ~ 31
TS-Brightness Night		Night adj range 0 ~ 31
TS-Auto Standby		Tap to enable or disable TFT Auto Standby function and Auto Screen shutdown. TFT goes into standby after selected time.

i NOTE

Using the DISP button you can set the display brightness to three levels (☞ 100% → 50% → 0% ☜).

CAR (VEHICLE) SETUP

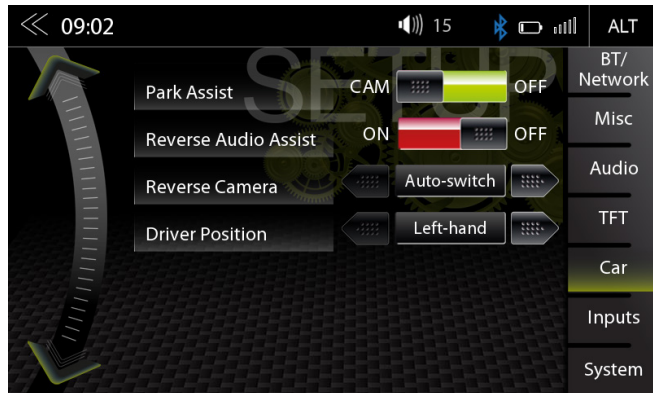

In the Car Setup menu, you can set how the ZENEC device interacts with optional components such as cameras and parking assist inside the vehicle. In addition, it can be defined whether the vehicle is a right or left-hand drive.

Function	Icon	Operation
Car (vehicle)		Tap to access vehicle configurations
Park Assist		CAM / OFF CAM = Camera On OFF = Camera Off
Reverse Audio Assist		ON / OFF
CAM auto-switch		Tap to set camera switching logic. (Auto-switching between F-CAM and R-CAM, direct front camera or direct rear camera)
Driver Position		Tap to set either Right-hand-drive or Left-hand-drive

INPUT SETUP

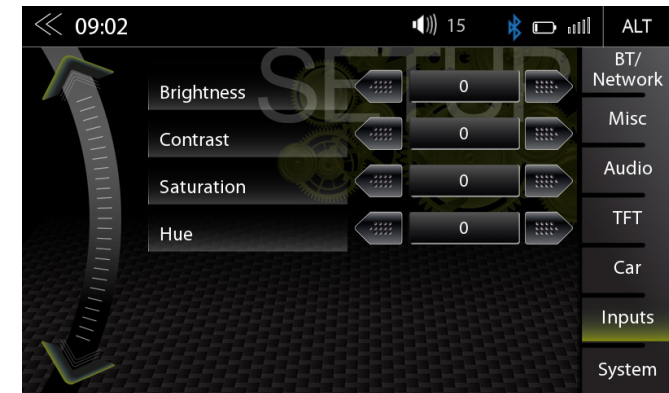

In the Input Setup menu, you can adjust the image settings of the connected video sources, such as Reverse Cameras. Contrast, brightness, color saturation and hue can be adjusted.

Function	Icon	Operation
Inputs		Tap to adjust image setup configuration of connected external video sources (e.g. rear view camera., etc.)
Brightness		-10 to +10
Contrast		-10 to +10
Saturation		-10 to +10
Hue		-10 to +10

SYSTEM SETUP



In the System Setup menu page, you can make various system settings, such as: Adjust the Clock Time, Load Factory settings, Initiate Software Updates or set a Password.

Function	Icon	Operation
System		Tap to access various system settings
SW Versions Info		Tap to access detailed software version information
Load Factory		Tap and confirm to reset the ZENEC system to factory default
Clock Time Setup		Tap to adjust clock time
Software Update		Tap and confirm to initiate a software update. www.zenec.com → Support → Softwareupdates
Navi Update		Tap and confirm to carry out a GPS navigation software update or a new installation of the navigation software.
Password Function		OFF = password protection disabled ON = password protection enabled
Password		Tap and confirm to store a password
Export to USB		Tap and confirm to save your full profile settings to external data media (USB). (FAT32 formatting)
Load from USB		Tap and confirm to load your saved device profile settings from external media carrier (USB) back into the ZENEC system

SOFTWARE VERSION

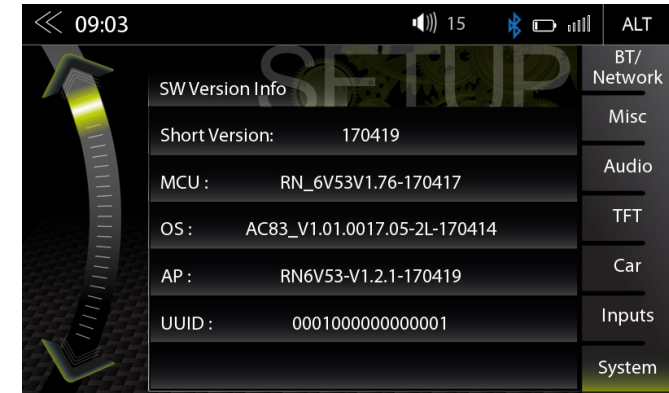

In the System Setup menu page under SW version, you will see the currently installed software versions with detailed version info for MCU, OS and AP, inclusive a simple Short Software Version.

Function	Icon	Operation
System		Tap to access this view
SW Version		Displays the current software version information

CLOCK TIME

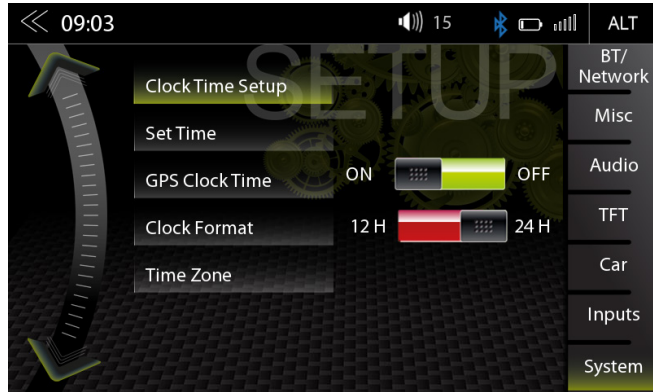

In the System Setup menu page under Clock Time, you can set the format, change the displayed time and select the time sync source (system time or GPS) for the time display.

Function	Icon	Operation
Clock Time setup		No function – text only
Set Time		Tap to change clock time
GPS Clock Time		ON / OFF ON = use GPS time OFF = use the internal system clock time
Clock Format		12 H / 24 H
Time Zone		Tap, to set the time zone

PASSWORD

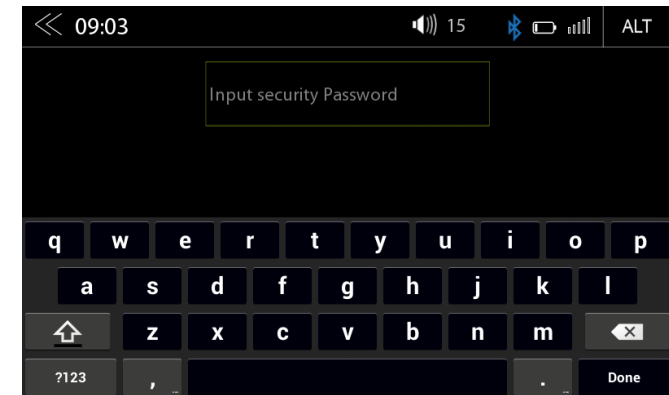
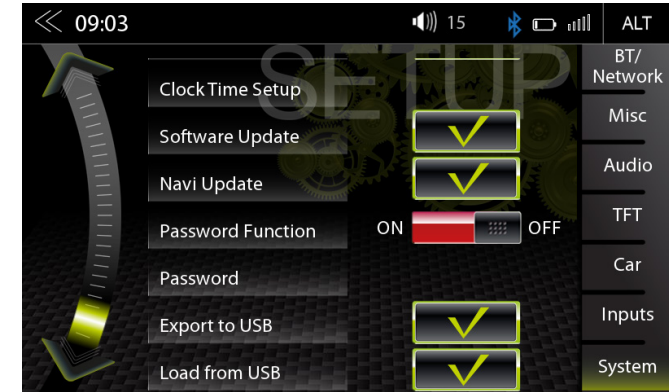

In the System Setup menu page under Password function, you can activate and deactivate the password protection.

Function	Icon	Operation
Password Function		OFF = password protection disabled ON = password protection enabled
Password		Tap and confirm to store a password*
Input Keypad		Enter the desired password

⚠ CAUTION

* If you protect you ZENEC system with a Password make sure, you have access to this password anytime.
Lost or forgotten Passwords require the device to be uninstalled and sent in to ZENEC Service Centre. Device unlocking is not free of charge.

INSTALLATION NOTES

⚠ CAUTION

- The installation of the ZENEC system should be carried out by an authorized installer. Specific knowledge and tools are required to do the installation. Incorrect installation can cause damage to the vehicle and the ZENEC system.
- Correct functioning can only be guaranteed when you use the ZENEC original accessories included in the kit or those optionally available. The ZENEC system and the original accessories must under no circumstances be modified or altered in any way. Inappropriate actions can cause damage to the vehicle and the ZENEC system.

i NOTE

- The ZENEC system is not compatible with vehicles, which are equipped with a hybrid or electro drive ex factory.
- The ZENEC Z-N426 is equipped with an integrated DAB+ receiver. To make use of this you will need a suitable DAB antenna (not included in kit) that must be connected to the ZENEC system.
- If the target vehicle is already equipped with an original DAB antenna, it is still possible to use it in combination with the ZENEC system.
- The set of this ZENEC device also contains a 2.4GHz Wifi dongle. This dongle can be connected to the designated USB wire on the device backside.
- Software updates to the ZENEC system are installed with a USB memory device. Therefore when fitting the system make sure that the USB connection of the ZENEC system will still be accessible later (installation of USB extension cable or USB hub).
- If you have questions or problems relating to the ZENEC system, please contact the dealer from whom you purchased it.

REMOVAL WORK AND PREPARATION

i NOTE

1. Remove the ignition key and keep it outside the car until the installation is finished.
2. Please wait for ca. 10 minutes until the CAN bus system is completely shut down, before you start with the deinstallation of the original device.
3. Start with the deinstallation of the original device.
4. Please switch on the ignition only, when all work steps are done and the ZENEC system is completely mounted.

i NOTE

- Make sure that all connectors at the rear of the ZENEC system have sufficient room and are not bent.
- Connectors without a retaining mechanism must be additionally secured with insulating tape.

OVERVIEW INCLUDED ACCESSORIES



No.	Article	Qty
1	Main device user manual	1
2	2DIN trim frame	1
3	2DIN metal device mounting cage	1
4	ISO-DIN main harness	1
5	Camera / Reverse Signal / Steering Wheel Control interface	1
6	4.2 RCA preamp line out	1
7	Bluetooth RCA preamp line out	1
8	USB extension cable	1
9	Parking break wire	1
10	GPS antenna with cable and Fakra connector	1
11	Bluetooth microphone with mounting clip	1
12	Factory radio removal tool	1
13	2.4GHz Wifi dongle	1

COMMISSIONING

Make sure that the vehicle is located outside, and that the GPS reception is not adversely affected by any shadowing (trees, high buildings etc.). Now insert the navigation software SD card supplied into the microSD card slot of the ZENEC system, and start it in order to establish a sat fix. Make sure that the vehicle is not moved until the sat fix is established. Now press the NAV button to start the navigation mode, and choose map view. Once your present location can be seen in the map view the sat fix has been established. This can take 3 to 5 minutes. You can now use the ZENEC system.

Finally carry out a general functional test and perform the basic and car specific settings (AC, OPS etc.). Also ensure that no fault warnings appear on the vehicle side.

CONNECTION DIAGRAM Z-N326 AND Z-N426

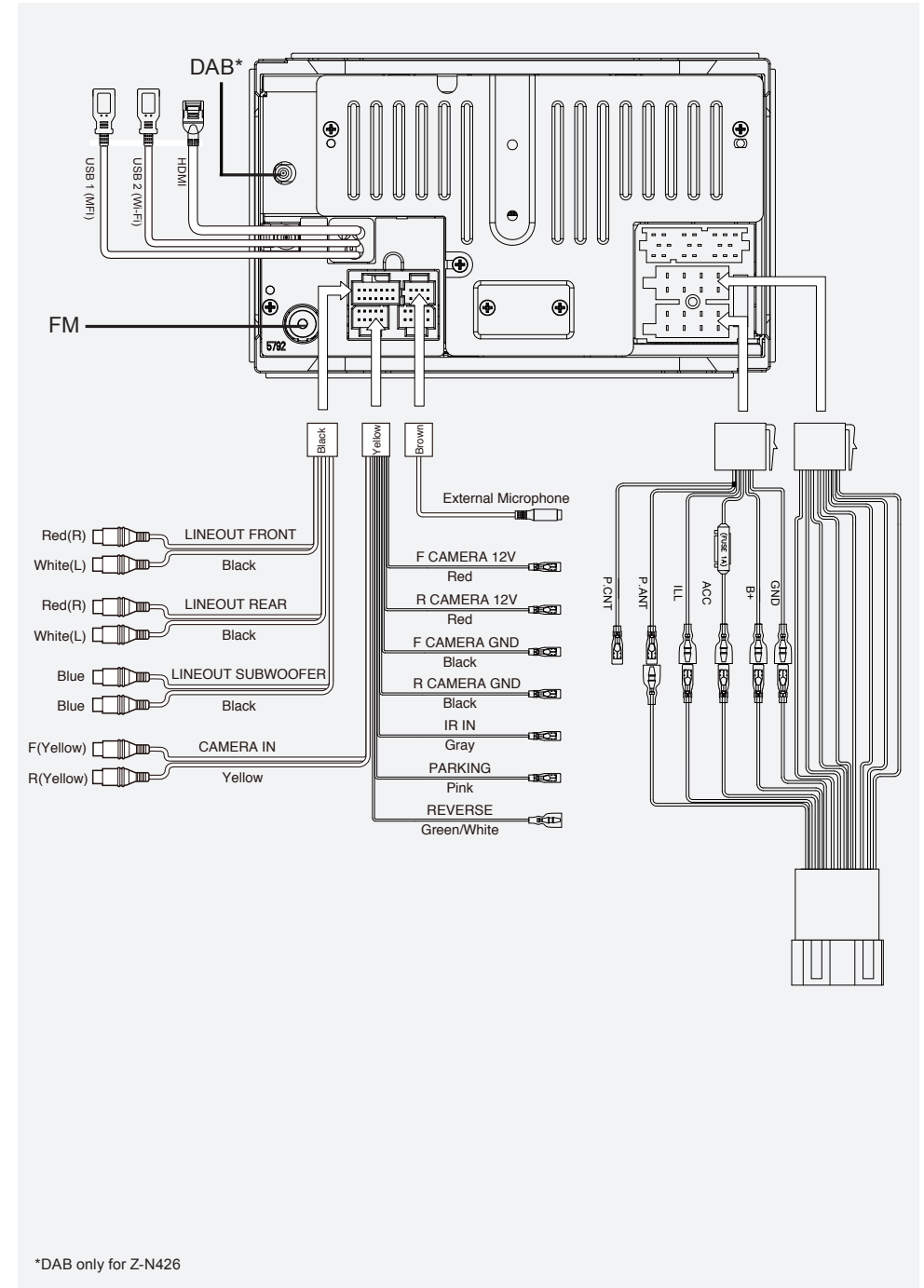
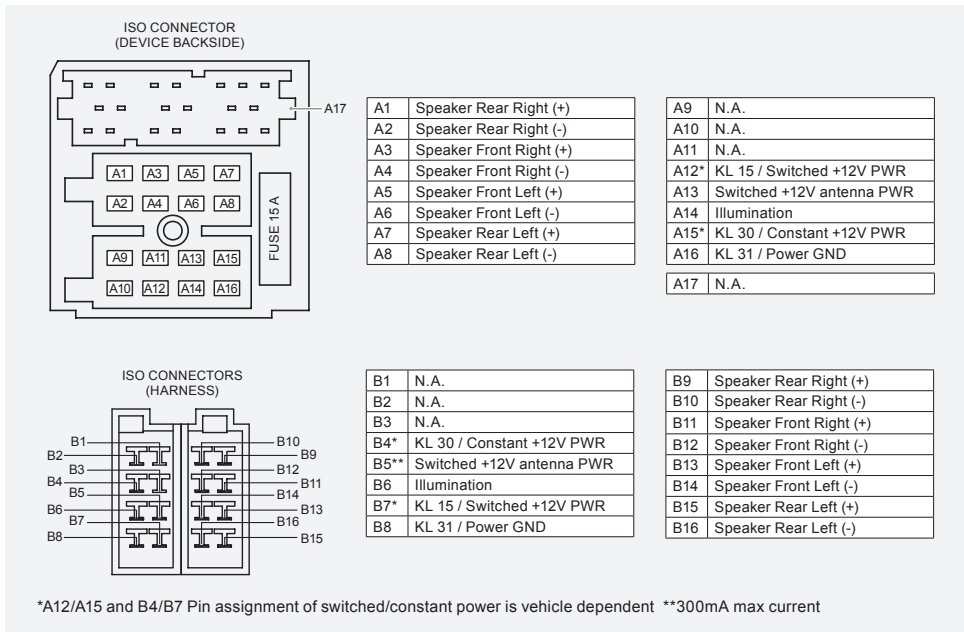
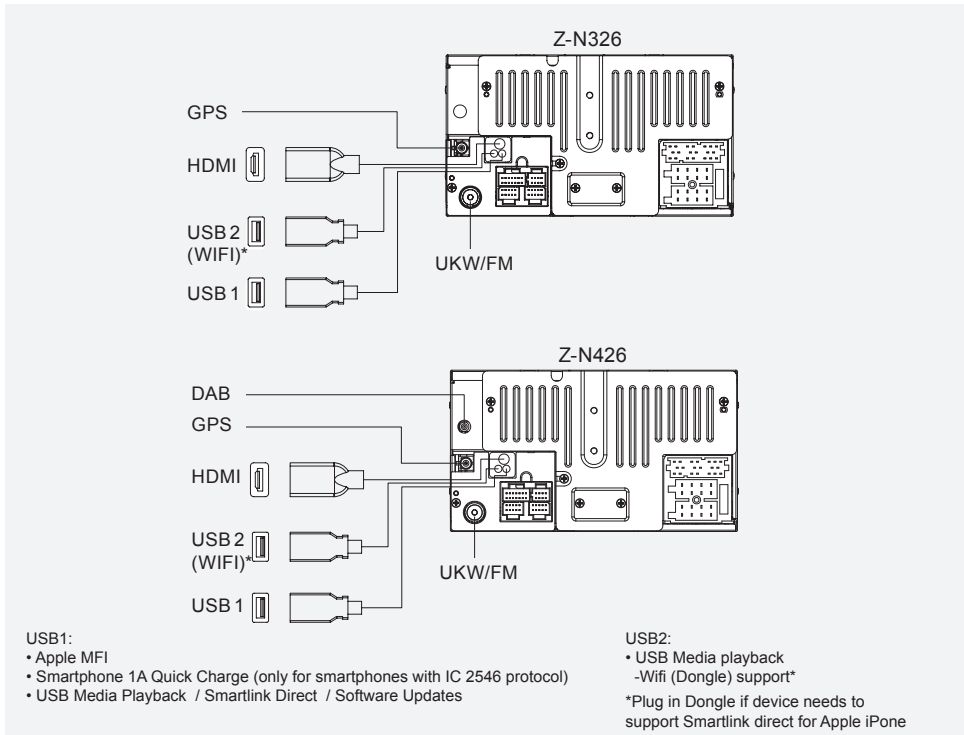

GENERAL

ABBREVIATIONS

Abbreviation	Description
A2DP	Manufacturer-independent Bluetooth® technology allowing audio signals to be transmitted (Advanced Audio Distribution Profile)
AF	Alternative frequency
CAN-Bus	The CAN bus (Controller Area Network) is a serial bus system for the communication of control units in a vehicle
DAB / DAB+	Transmission standard for terrestrial reception of digital radio (Digital Audio Broadcasting)
DSP	The digital signal processor is used for the processing of digital signals (e.g. audio or video signals)
EQ	Equalizer
FAT32	Formatting format for digital media (File allocation table 32-bit)
UKW/FM	Transmission standard for terrestrial reception of very high frequency analog radio (UKW)
GPS	Global navigation satellite system for position fixing (Global Positioning System)
GSM	Global mobile radio network standard for fully digital mobile radio networks (Global System for Mobile Communications)
ID3-Tag	ID3 tags mean meta data, which could be included together with the MP3 format.
microSD	Compact flash memory
REG	Regional station
SSP	Secure Simple Pairing (for Bluetooth devices)
TA	Traffic Announcement (RDS service)
USB	A USB connection is a serial bus system for connecting a device to other devices (Universal Serial Bus).

STATUTORY RIGHTS AND WARRANTY

Dear customer,

Please read the warranty specifications below carefully.

Should your ZENEC product require warranty service, please return it to the retailer from whom it was purchased or the distributor of your country. Do not send any product to ZENEC directly.

This ZENEC product is protected against defective materials and/or improper workmanship by a factory warranty, for the period of two years from date of purchase at retail, to the original buyer.

For warranty work to be carried out, an RMA number must be generated, which requires a valid product serial number and the original sales slip.

Guarantee Restrictions

This warranty does not cover any damage due to:

1. Unauthorized or unapproved installation, incorrect audio or mains connection(s).
2. Defects caused by exposure of product to humidity, water and organic fluids, prolonged exposure to sun rays or excessive dirt or dust.
3. Mechanical defects caused by accidents, fall or impact.
4. Unauthorized repair attempts and modifications of product not explicitly authorized by the manufacturer.

This warranty is limited to the repair or the replacement of the defective product at the manufacturer's option and does not include any other form of damage, whether incidental, consequential or otherwise. The warranty does not cover any transport costs or damages caused by transport or shipment of the product. Any additional or further claims and requirements for compensation of auxiliary components that have been damaged in sequence, directly or indirectly, are strictly excluded.

EU Legal Representative: ACR S & V GmbH · Industriestraße 35 · D-79787 Lauchringen · Germany
ZENEC by ACR AG · Bohrturmweg 1 · CH-5330 Bad Zurzach · Switzerland

www.zenec.com

 Z-N326: E4 10R-05 3762
Z-N426: E4 10R-05 3800

© Copyright 2017

RevA / copy deadline: Q2-2017

English

Manufacturer: ACR AG · Bohrturmweg 1 · CH-5330 Bad Zurzach · Switzerland

EU Legal Representative: ACR S & V GmbH · Industriestraße 35 · D-79787 Lauchringen · Germany